

HSEUiREG07201

720W Lab Power Supply DIN-Rail

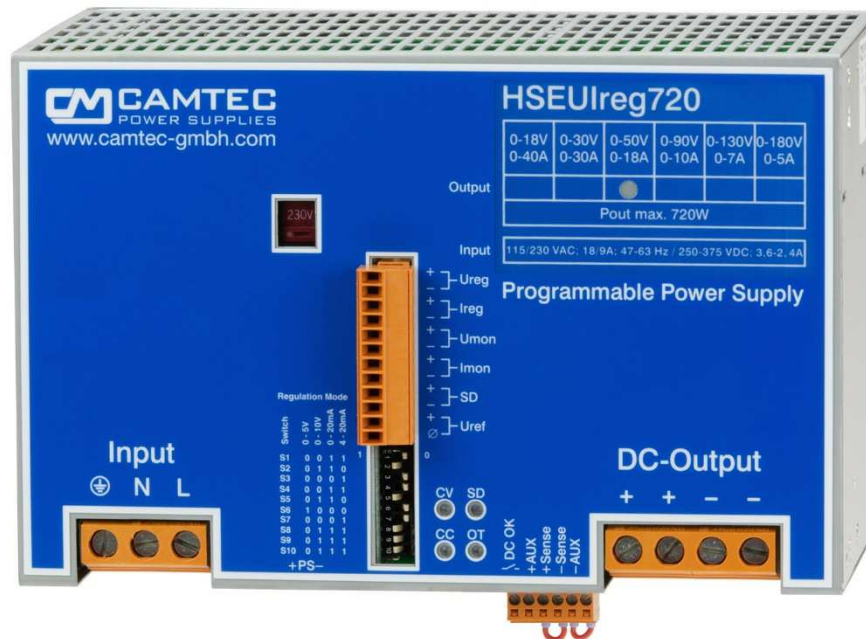

Features:

- Real time voltage programming
- Real time & value C/V-monitoring
- Reference voltage f. autonomous programming
- Remote Shutdown
- Sense control 2V per load line
- Power Good Relay DC-ok
- Quick down programming option PS
- Precise dynamics on load change
- Series & parallel operation N+1
- Natural convection
- Electronic Inrush Limiter 13,8Arms
- Up to 90% efficiency
- EMI/EMS EN61000-6-2,3, EN55032 class B
- EN61010-1, EN61010-2-201, EN62368-1

Model	Voltage programmable	Current programmable
HSEUiREG07201.018	0 – 18Vdc	0 – 40,0A
HSEUiREG07201.030	0 – 30Vdc	0 – 30,0A
HSEUiREG07201.050	0 – 50Vdc	0 – 18,0A
HSEUiREG07201.060	0 – 60Vdc	0 – 15,0A
HSEUiREG07201.090	0 – 90Vdc	0 – 10,0A
HSEUiREG07201.130	0 – 130Vdc	0 – 7,0A
HSEUiREG07201.180	0 – 180Vdc	0 – 5,0A
HSEUiREG07201.240	0 – 240Vdc	0 – 3,8A





Technical description

The Camtec HSEUiREG models are high-precision lab power supplies „Made in Germany“. These power supplies are designed for power systems in the testing automation.

For more than 25 years the Camtec Power Supplies manufactures high-end switch mode power supplies in Germany. A field breakdown of below 0,004% over a 10-year period under review approves our ambitious quality concept. Each manufactured Camtec product passes several 100% tests for each detailed function and a full-load Burn-In test.

Although it is not required from the safety norms our production applies a routine safety test to each manufactured device, even if it is an extra low-voltage model. The components in the assembled device pass stress aging to achieve an even level and to prevent from delayed failures. Our internal product engineering guidelines provide a clear target: Camtec product reputation must say „mount and forget“. Quality is never a mere promise for our team.

The HSEUiREG laboratory power supplies provide low noise and ripple, a very quick programming, and a precise setting at high load changes. With an efficiency up to 90% the devices are highly energy efficient.

Equipped with high-end capacitors of outstanding lifetime our power supplies guarantee a very long and reliable operation time. The circuit design of the HSEUiREG Series allows cope playing with complex loads. The internal protection circuits protect the power supply and the connected system, even in exceptional situations. The HSEUiREG series is protected from high transients by strong filters with high energy efficiency. All inputs and outputs are electrically isolated. The design specifications call for the highest standards of safety and interference suppression. The unit is designed in accordance with the EN61010-1, EN61010-2-201, EN62368-1, EN60950-1, and the EMC-compatibility with EN55032.

The special heat emission design supports easy baseplate cooling with the help of an optional wall mount plate.

Features

Idling behavior

The HSEUiREG Series is permanently open-circuit proof. When an output voltage is preset it comes stable. If a load is switched suddenly, the unit stabilizes within <1ms. An overshoot of the output voltage is irrelevant.

Start behavior

The power supply has a start delay of 420ms to stabilize all measuring circuits for the interface messages accurately. The power supply starts with a ramp (soft start) of 100ms. The output voltage does not overshoot - regardless of whether a load is connected or not.

Galvanic isolation and insulation

The switching power supply is galvanically isolated between the input and the output. The sensing, Ureg, Ireg, Umon, Imon and Iref are connected to the DC power output.

Voltage programming (Ureg)

The output voltage of the HSEUiREG power supply can be adjusted by a control signal. The setting is linear to the input signal.

Current programming (Ireg)

The output current of the HSEUiREG power supply can be adjusted by a control signal. The setting is linear to the input signal.

Voltage Monitor (Umon)

The power supply provides real-time monitoring of the output voltage. It is the exact and real value at the output terminals. If the sense line is used, the real value is measured directly at the load. The latency signal preset to the measured value is negligible since the control circuit is constructed completely analogously.

Current Monitor (Imon)

The power supply provides real-time monitoring of the output current. It is the exact and real value at the output terminals. The latency signal preset to the measured value is negligible since the control circuit is constructed completely analogously.

Constant Voltage or Constant Current Mode (CV/CC)

The device can optionally be operated as a DC voltage source or a constant current source. The operating mode is signaled via LED.

Reference Voltage (Uref)

The devices feature an auxiliary reference voltage to operate external potentiometers. The Uref voltage can be set to 5,2V or 10,4V 5mA via the DIP-switch.

Sense Mode

The power supply has a sense mode to compensate for voltage drops of 2V per load line.

External Shutdown (SD)

All the models are featured with an external shutdown (switch/open collector)

Digitale Interface

The standard equipment of the power supply is an analog interface.

Optionally, the unit can be equipped upon request with a digital USB 2.0 interface. Options include a software and a DOM interface for easy control over standard software like LabView or others.

DC Power Good Relay

The power good relay connection indicates over device temperature and low AC supply voltage.

Over Temperature Thermal Shutdown (OT)

The device has a thermal monitoring: shutdown with automatic restart.

Fast Down Programming & PowerSink (PS)

For fast down programming an internal PowerSink is offered as an option. The current sink discharges the output electrolytic capacitors and eliminates back feed energy. A further output allows to control external PowerSink modules. The internal current sink for quick programming must be installed at the factory.

ST-HD (ST Heat Dissipation)

Our aligned and controlled heat dissipation design opens possibilities that are formerly being reserved to custom design power supplies: Hard mount of the HSEUiREG power supply modules on a wall allows easy access to base plate cooling.

In practice that means that one can mount the modules onto a thermal conducting wall to ensure that a significant part of the losses will be transported directly out of the power supply unit.



Technical Data Table

AC Input Range	90-132Vac, 184-264Vac (115/230Vac input selector, factory setting is 230Vac)							
AC Input Frequency	47-63Hz							
DC Input Range	250-375Vdc (input selector set to 230Vac)							
AC Input Rated	115Vac < 12,7A, 230Vac < 7,2A							
DC Input Rated	250Vdc < 3,6A 375Vdc < 2,4A							
DC Voltage programmable	0 - 18Vdc	0 - 30Vdc	0 - 50Vdc	0 - 60Vdc	0 - 90Vdc	0 - 130Vdc	0 - 180Vdc	0 - 240Vdc
DC Current programmable	0 - 40A	0 - 30A	0 - 18A	0 - 15A	0 - 10A	0 - 7A	0 - 5A	0 - 3,8A
Over Voltage Protection	22Vdc	35Vdc	59Vdc	70Vdc	105Vdc	150Vdc	210Vdc	280Vdc
Over Current Protection	44A	33A	19,8A	16,5A	11A	7,7A	5,5A	4,2A
Ripple Noise 230Vac 20MHz	40mVpp	40mVpp	100mVpp	120mVpp	150mVpp	200mVpp	300mVpp	400mVpp
Ripple RMS	14mV	14mV	35mV	42mV	63mV	71mV	106mV	141mV
Load Regulation 0-100%	< ±0,05%	< ±0,05%	< ±0,05%	< ±0,05%	< ±0,05%	< ±0,05%	< ±0,05%	< ±0,05%
Power Maximum	720W, 90-132Vac, 184-264Vac							
Cooling	Natural convection							
Efficiency	Up to 90% 230Vac at full load							
Short Circuit Resistance	yes							
Open Circuit Protected	yes							
Base Load (OCP)	Non required (open circuit protected)							
Load Regulation Time	<1ms on load switch 10-100%							
Interface Signal Accuracy	Ureg: ≤ ± 0,5%, Ireg: ≤ ± 1,5%, Umon: ≤ ± 0,5%, Imon: ≤ ± 1,5%, Uref: ≤ ± 1,0%							
Interface Signal Latency	Umon/Imon < 0,1ms on signal change							
Temperature Control	yes, thermal shutdown & autorecovery (+60°C, outside measuring point distance 50mm)							
Hold Up Time	>40ms 230Vac mains buffering at full load							
Inrush Current	<9,8Arms <13,8Apeak 230Vac active electronic inrush protection (no simple NTC)							
MCB (Circuit Breaker)	16A curve B @ 230Vac / 25A curve B @ 115Vac							
Start-up Delay	Typ. 420ms @ 230Vac, 590ms @ 115Vac							
Softstart	Typ. 100ms							
Start-up from Shutdown	Typ. 330ms							
Ambient Temperature	- 20°C...+60°C operating, derating 2,5%/°C >50°C							
Storage Temperature	- 40°C...+85°C							
Ambient Conditions	Humidity 95% non-condensing @ 25°C, climate class 3K3, pollution degree 2							
ROHS	2011/65/EU, (EU)2015/863							
REACH	EG No. 1907/2006							
EMI	EN55032 class B, EN61000-6-3							
EMS	EN61000-6-2							
Safety	EN61010-1, EN61010-2-201, EN62368-1, EN60950-1, EN60204-1							
Protection Class I	PE connection required							
Isolation Input to Output	3000Vac							
Isolation Input to Case	2500Vac							
Isolation Output to Case	500Vdc, ≥60Vdc 2500Vdc							
MTBF (IEC61709)	400000h (Meantime Between Failures: statistic time between failures after repairs)							
MTTF (IEC61709)	147212h (Meantime To Failure: statistic time to ever fails)							
Dimensions (HxWxD)	130x200x115mm							
Weight	3,1kg / 6,8lbs							
AC Terminals	Input Screw Terminal 3x 0,5 – 16mm ² AWG26 – AWG6 (L,N,PE), technical data see “connections”							
DC Terminals	Output Screw Terminal 4x 0,5 – 16mm ² AWG26 – AWG6 (+ + / - -), technical data see “connections”							

Manual and Technical Details

Programming Time Vout [ms]

Model	0-18V	0-30V	0-50V	0-60V	0-90V	0-130V	0-180V	0-240V
Rise Time 0-100%, 10/100% load, [ms] typ.	15/15	15/15	15/15	15/15	15/15	15/15	15/15	15/15
Slew Rate 90-10%, 10/100% load, [ms] typ.	37/3,7	104/10,4	51/5,1	74/7,4	57/5,7	53/5,3	100/10	83/8,3
Slew Rate PS-Option 100-0%, 0% load, [ms] typ.	100	100	100	100	100	100	100	100
Output Capacity, [mF] typ.	10,4	10,4	1,85	1,85	0,64	0,28	0,28	0,13

Analog Interface CON-A (Connector Model Weidmueller 1597460000 = included)

Pin	Name	Type	Function	Signal	Remarks
1	Ureg +	Input	Voltage Programming	Select 0-5V, 0-10V, 0-20mA, 4-20mA	1 MΩ working resistance with Vprog 500 Ω working resistance with Iprog
2	Ureg -	Input			
3	Ireg +	Input	Current Programming	Select 0-5V, 0-10V, 0-20mA, 4-20mA	1 MΩ working resistance with Vprog 500 Ω working resistance with Iprog
4	Ireg -	Input			
5	Umon +	Output	Voltage Monitor	Select 0-5Vdc/5mA, 0-10Vdc/5mA	
6	Umon -	Output			
7	Imon +	Output	Current Monitor	Select 0-5Vdc/5mA, 0-10Vdc/5mA	
8	Imon -	Output			
9	SD +	Input	Control Signal Shutdown	Switch / Open Collector	
10	SD -	Input			
11	Uref +	Output	Reference Voltage	Select 5,2Vdc or 10,4Vdc 5mA	
12	Uref -	Output			

Analog Interface CON-B (Connector Model Weidmueller 159740000 = included)

Pin	Name	Type	Function	Signal	Remarks
1	DC-OK	Output	Closers, Signal DC OK	Relay	Potential-free break contact
2	DC-OK	Output			
3	AUX +	Output			
4	Sense +	Input			
5	Sense -	Input			
6	AUX -	Output			

Analog Interface CON-C (Connector Model Weidmueller 1597360000 = not included)

PS +	PS +	Output	External Power-Sink	Trigger	This connection is without function for the standard HSEUiREG1500
PS -	PS -	Output			

Configuration of the Analog Interface via Dip-Switch

Mode	S1	S2	S3	S4	S5	S6	S7	S8	S9	S10
0-5V	0	0	0	0	0	1	0	0	0	0
0-10V	0	1	0	0	1	0	0	1	1	1
0-20mA	1	1	0	1	1	0	0	1	1	1
4-20mA	1	0	1	1	0	0	1	1	1	1

LED Signal Indication

LED	Over Temp.	Shut Down	Constant [V]	Constant [C]
CV	OFF	OFF	ON	OFF
CC	OFF	OFF	OFF	ON
OT	ON	OFF	OFF	OFF
SD	OFF	ON	OFF	OFF

Monitor Outputs	Monitor Connections	Potentiometer Programming
Programming Inputs	Shutdown	Power OK Relay

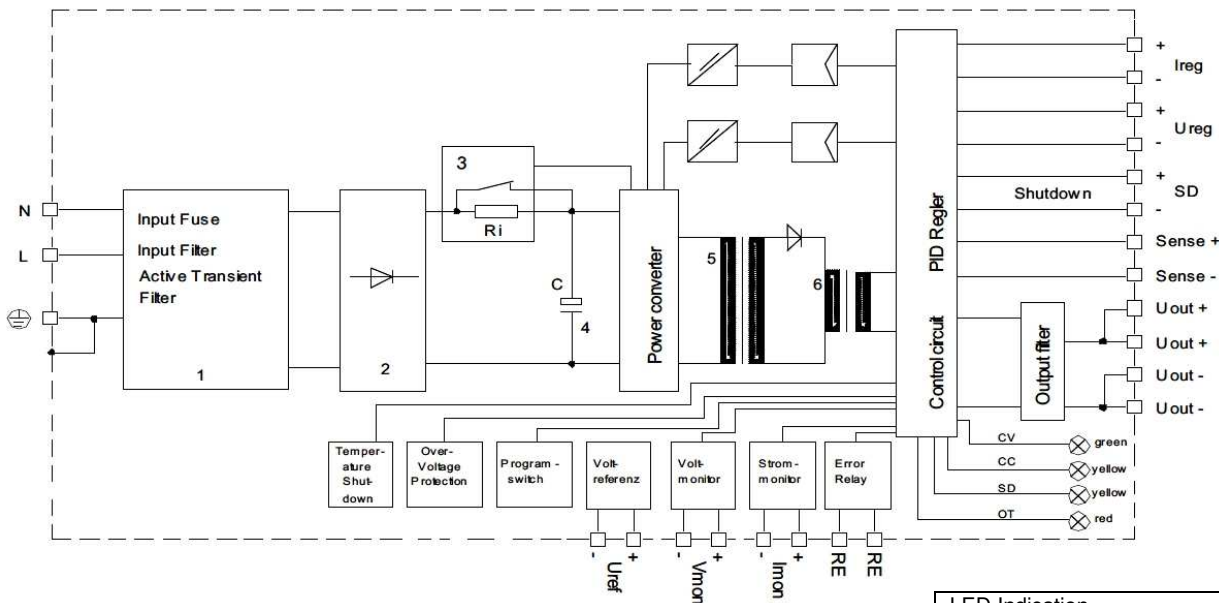

LED Indication		
CV	GRN	Constant voltage
CC	YEL	Constant current
SD	YEL	Shutdown
OT	RED	Over temperature

Programming/Monitoring V/C Analog Interface (Ureg /Ireg) (Umon/Imon)

The standard programming of the HSEUiREG Series is an analog interface. The output voltage is linearly proportional to the adjusted analog control signal. If the control signal 0V and/or 0A applies the power supply delivers 0V at the output. The power supply is already working from 0V output voltage and low load with high precision.

The monitor signal is analog linear to the output voltage. The monitor signal for current and voltage is the real value that is measured directly at the output of the power supply. If a sense line is connected to compensate for the voltage drop across the load lines, the monitor signal is exactly the value that is measured at the connection point of the sense line. The description of the power supply in the sense operation is carried out in a separate section.

The analog inputs and outputs are non-floating. The mass is connected to the DC negative output.

The adapter provides the ability to select the desired input / output via a DIP switch. The burden of the control voltages is 1M Ω . The burden of the current interface is 500 Ω . The latency to full compensation of V/C on the interface from 0-100% is 15ms for all HSEUiREG models.

If the power supply is operated with a low load, the down-programming time up to the desired set point may be very long. The power supply has large built-in capacitors and an enormous energy reserve. A similar effect occurs by skidding input energy, which is not easily removed from the power supply. A PowerSink (PS) modul can be ordered as an option for each HSEUiREG power supply unit. The PS option is used for fast down programming and the degradation of skidding energy fed. The option must be equipped in the factory.

For further information about the PS option, please refer to the technical details in a section PS-option.

Compensation of Load Line Drop Voltage (Sense +/-), standard operation mode

The HSEUiREG power supply has a Sense Mode to compensate for the voltage drop over long load lines. The compensation amounts to a maximum of 2V per load line. Under certain circumstances, it can be expected to apply more complicated external interference suppression. If sense is not used, Sense + and Sense - shall necessarily be connected by short bridges to AUX + and AUX - (factory setup). Make sure that +/- connections are matching! **WARNING!** Reverse polarity of the sense lines can cause damages to the power supply unit.

Sense operation: Remove the bridges between Sense +, Sense -. Connect the sense lines directly to the load. Pay attention to the polarity of plus and minus of the load to prevent damage to the power supply. To avoid interference, twist the sense lines. To reduce inductive effects, we recommend that the load lines position is close to each other. To supply a pulsating load, the use of an electrolytic capacitor and a ceramic capacitor has proved. The internal Over Voltage Protection (OVP) of the power supply controls the DC power directly to the DC output terminals. In case of an error the OVP acts automatically (see OVP values corresponding table).

The sense terminals are directly connected to the power outputs.

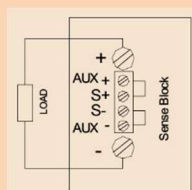

Lokal Sensing
(factory setup)

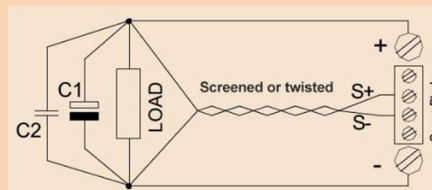

Remote Sensing
(twisted sense lines)

Compensation Load Line Voltage Drop (Sense +/-) battery charger operation mode

Remote Sensing as a battery charger

If the HSEUiREG power supply unit is used as a battery charger, it is recommended to refrain from sensing. It can lead to severe damage to the power supply, if the polarity of the sense line is confused (field experience: such error often occurs when system service is required, e.g., when the batteries are changed). If it is necessary to use sensing, proceed as described in the figure below. Proven approaches are 250mA for the fuses and 3...5A load capacity of diodes.

WARNING! Reverse polarity of the sense lines can cause damages to the power supply unit.



External Shutdown (SD)

The power supply is set to the Shutdown mode, when the control input is either shorted via a relay contact, a switch contact or an NPN transistor with open collector (voltage drop <1V, current typ. 2mA).

If the shutdown repeals the power supply starts again.

Using the soft-start, the current and the voltage rises within continuously to the default set values.

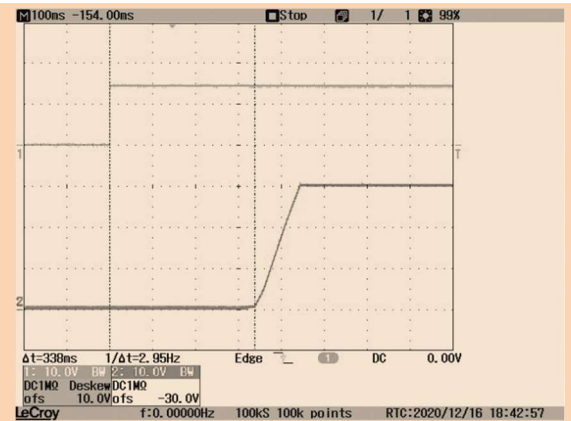

Power-OK Relay (DC Power Good)

The alarm signal DC OK has potential-free relay contacts. The contacts are closed (relay coil is energized) when the power output is active. In shut down mode (SD) the contacts are closed.

The contacts are open when the power output is inhibited by OT or low AC supply voltage at the AC inputs. Contact load (resistive load): 30Vdc/1A, 60Vdc/0.3A, 30Vac/0.5A.

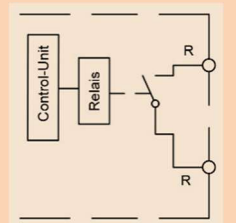

Over Voltage Protection (OVP)

If an over-voltage occurs to the output (for example, defective components, external feed voltage), it is followed by the shutdown of the power output. A periodic restart attempts (ticker operation period 400ms).

Over Temperature Shutdown (OT)

The alarm LED OT lits when the temperature of the LED supply is higher than the over-temperature protection threshold.

C/V Chart and Operating Point

The output voltage set V_{out} is always linear proportional to the control signal U_{reg} .

The desired control signal is selected via the DIP switch:
0-5V, 0-10V, 0-20mA oder 4-20mA.

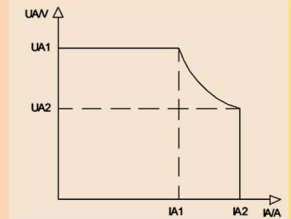

Model	Value UA1 (V)	Value IA1 (A)	Value UA2 (V)	Value IA2 (A)	Pmax (IA1/IA2)
HSEUiREG07201.018	18Vdc	40,0A	18Vdc	40,0A	720/720W
HSEUiREG07201.030	30Vdc	24,0A	24Vdc	30,0A	720/720W
HSEUiREG07201.050	50Vdc	14,4A	40Vdc	18,0A	720/720W
HSEUiREG07201.060	60Vdc	12,0A	48Vdc	15,0A	720/720W
HSEUiREG07201.090	90Vdc	8,0A	72Vdc	10,0A	720/720W
HSEUiREG07201.130	130Vdc	5,5A	103Vdc	7,0A	715/721W
HSEUiREG07201.180	180Vdc	4,0A	144Vdc	5,0A	720/720W
HSEUiREG07201.240	240Vdc	3,0A	190Vdc	3,8A	720/722W

Inrush Current Protection (electronic)

The power supply unit has an electronic current limiter
(230Vac=9,8A_{rms}/13,8A_{peak}).

It is a precisely working circuit instead of a usual simple NTC solution. The accuracy is $\pm 10\%$, regardless of the operating temperature and the duty cycles (interval $\geq 10s$). We recommend the smallest circuit breaker a characteristic B with 25A for 115Vac and with 16A for 230Vac.

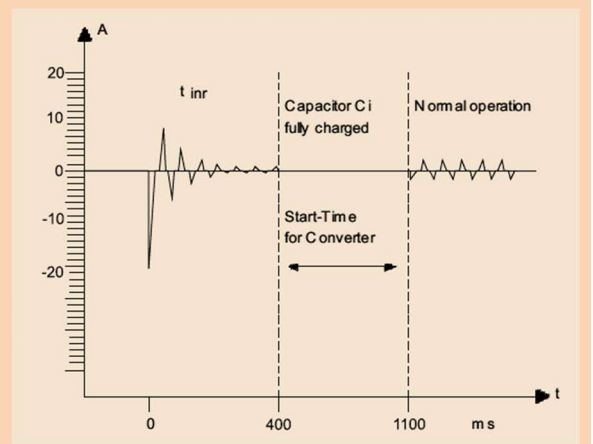
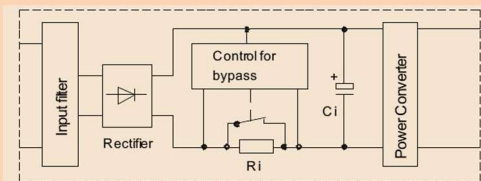

Temperature Derating

The maximum ambient temperature during operation is $+ 60^{\circ}C$. If the overtemperature protection is activated, the power supply is switched off.

The measuring point is 50mm outside the power supply. The power supply unit starts automatically when it has cooled down.

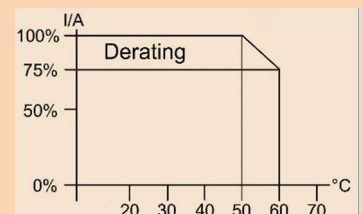

Series Operation

Two or more units of the same model and output voltage can be operated up to a total voltage of 300Vdc in series. Due to the dielectric strength of the internal components used, only the models with an output voltage of 90Vdc and later are approved for series operation. Other power supplies are not approved for series operation above 60Vdc.

If the units are remotely controlled via the analog interface it is compulsory to use a potential-free control voltage!

Parallel Operation & N+1 Decoupling

To increase the overall power of the power supply, two or more devices of the same model with the same output voltage may be operated in parallel. We recommend using a busbar for the DC power connector. Make sure that the cable lengths and cable cross-sections of all power supplies to the busbar or to the star point are identical. Allow proper connection for low contact resistance. If you want to use the sensing function, connect it also to the star point or busbar. To avoid measurement errors, select the line length from the neutral point or from the busbar to the load as short as possible and use the maximum possible conductor cross-section.

Up to 5 pcs HSEUiREG can be paralleled.

The HSEUiREG models have no internal O-ring diode, to operate the devices redundant N+1. We recommend using our RED00202 DIN-rail redundant device.

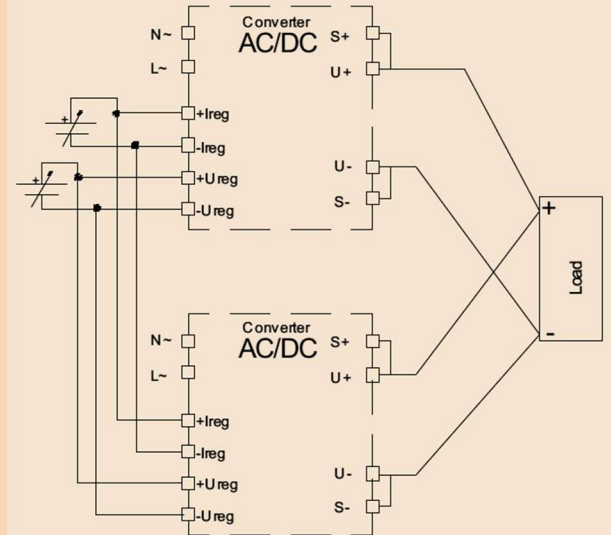

Electrical Safety (Factory-Test / Field-Test Owner)

	T	A	B	C ¹⁾	D
Type Test	60s	2500Vac	3000Vac	500Vdc	500Vdc
Factory Test	5s	2000Vac	2000Vac	500Vdc	500Vdc
Field Test	2s	2000Vac	2000Vac	500Vdc	500Vdc
Cut-off current setting		>20mA	>20mA	>1mA	>1mA

¹⁾ $\geq 60\text{Vdc} = 2500\text{Vdc}$

Type and factory test are the manufacturer. While repeating damage can happen to the power supply unit. For the field test (owner) follow the below instruction:

- Use suitable test equipment, raising the voltage slowly
- Short circuit L1 and N, and all the DC output terminals.
- Use only test voltages of 50/60Hz. The outputs are unearthed and therefore they have no resistance to GND/PE.
- If the residual voltage is $\geq 60\text{Vdc}$, observe the safety standards. Use only specially insulated screwdriver to trim the Ua/Ia.

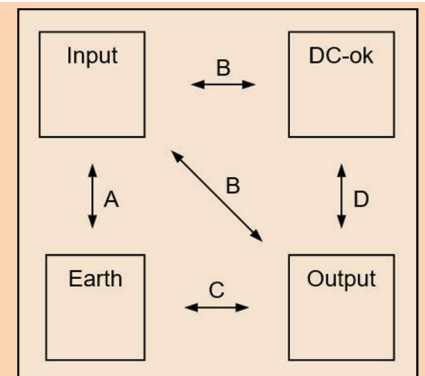

Available Options

PS Option for Quick Downward Programming (PSOPT)

Quick Down Programming:

The input capacitance of a power supply can be discharged only slowly at low load. A quick downward programming of the output voltage of an almost non-loaded power supply is not possible. This fact leads to undesirably long cycle times on a test bench. The PS option works as an electronic circuit. It communicates with the control circuit of the power supply and therefore permits a much higher dynamics of the system, as an external passive base load.

Maximum continuous power capability is 5W. Maximum switching frequency is 1Hz. The switching frequency must be reduced if external electrolytic capacitors are used.

Back-Feed Energy:

In the back-feed power by a consumer a regenerative current is charging the output capacitors. The output voltage will increase. The following formula shows $dv/dt=i/C$.

When an electronic current sink is used, the output voltage remains constant at the set value. The current sink provides a quick dynamic response.

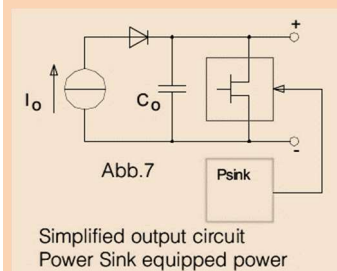

Fig 1

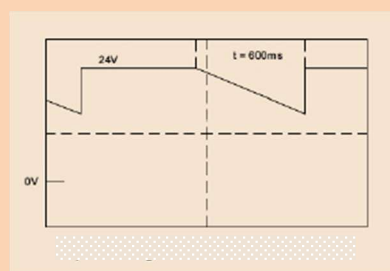

Fig 2

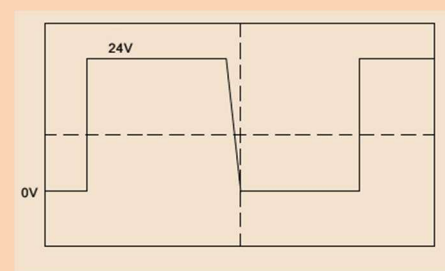

Fig 3

A Power Sink (see Fig. 1) enables fast down programming at low load conditions or without a load. For comparison, see Figure 2 (without) and Figure 3 (with PS option).

The PS-option must be installed in the plant because it is not accessible from the outside. It is necessary to match the power supply after installation and perform electrical safety testing. We therefore recommend a required a necessary PowerSink option to be purchased with the power supply unit.

Retrofit PS option:

Individual trained HSEUiREG dealer are pre-retrofit able. Alternatively, a HSEUiREG power supply may also be sent to the factory. Please apply for this an RMA number from our service.

Test Certificate and Calibration

Optionally we offer with the delivery of a HSEUiREG power supply a Manufacturer's Inspection Certificate of electrical setpoint / actual values. The power supply then is "calibrated". Such Manufacturers Calibration Certificate for each power supply can uniquely be assigned via the device serial number.

A manufacturer calibration of a HSEUiREG can frequently be done via controlled recirculation on a regular basis. Please request the help of your local HSEUiREG dealer or contact us directly:
service@camtec-gmbh.com

Mechanics

ST-HD Baseplate Cooling & Temperature Management

The temperature management of the HSEUiREG series provides a direct dissipation of the main energy losses. The internal coolers of the output diodes and the power FETs connect to the back-plate cooler. It is possible to dissipate about 40 – 50% of the energy losses out of a system while using the Baseplate cooling bundle 2201002001 to hard mount the unit to a plane and heat conductive surface.

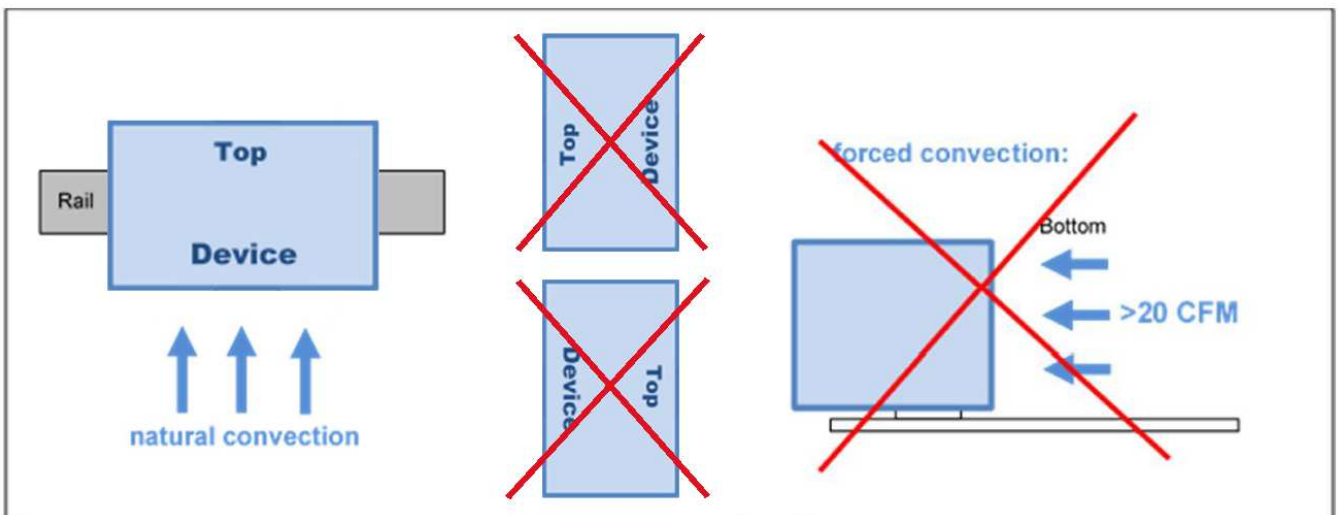
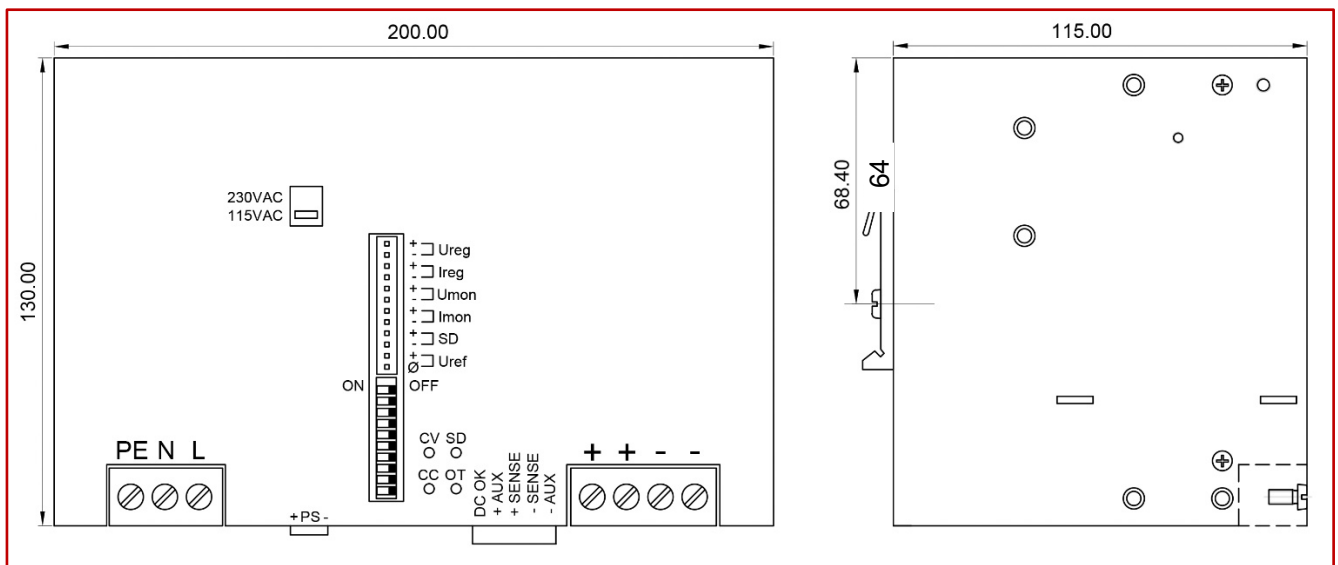

Mounting Instruction: recommended airflow space below and above is 50mm (2 Inch)

Mechanics & Installation Instruction of the HSEUiREG

Stable metal/aluminium housing IP20. To allow adequate convection, a free air space of 50mm (top/bottom) and 10mm (sidewalls) is required; and for active devices 15mm space from the sidewalls. For proper air convection it is necessary to install the HSEUiREG. One can use the DIN-Rail installation (equiped standard) with our patented 35mm DIN-Rail bracket according to EN60715. It is easy to mount/dismount while snapping it onto the 35mm DIN-Rail - no tools necessary. A wallmount back plate (option) is available, too.

It is not allowed to install the HSEUiREG in other mounting direction then as shown in the drawings.

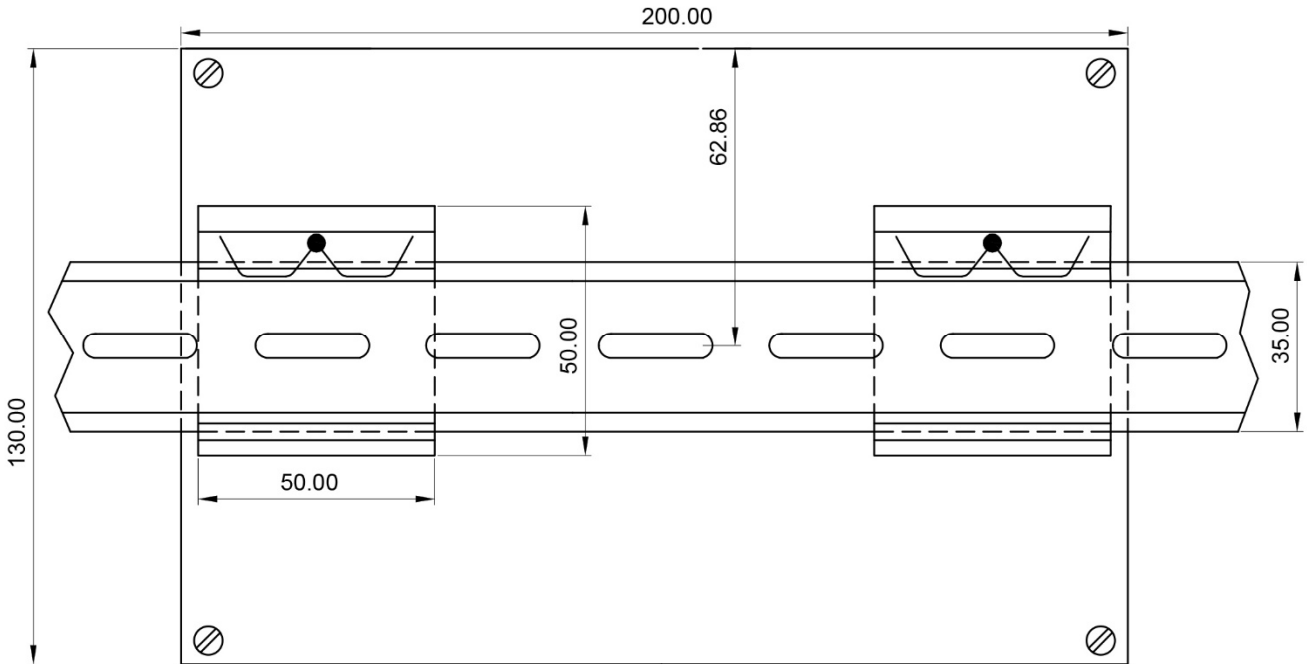

Back Plate Option / DIN-Rail Standard

(The HSEUiREG is always delivered for DIN-rail mount, the back-plate is an optional part that shall be mounted from the customer. The threads from the DIN-rail mounting brackets shall be used. All screws are included into the Back-Plate Kit.)

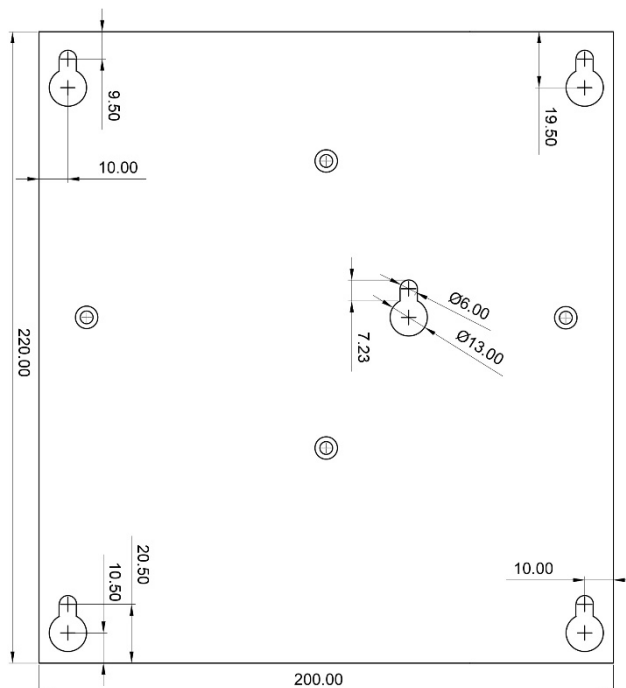

Connections

Clamping Yoke Connector Specifications

	Input / Output connections	Signal connections plugs
Tightening torque min. – max.	1,2 – 2,2Nm (blade 1,0x5,5 DIN5264)	0,2 – 0,25Nm (blade 0,4x2,2 DIN5264)
Touch-safe protection acc. to DIN VDE 0470	IP20 plugged/ IP10 unplugged	Not applicable
Clamping range, min. – max.	0,5 – 16mm ² / AWG26 – AWG6	0,2 – 1,5mm ² / AWG28 – AWG14
Solid, H05(07) V-U min. – max.	0,5 – 16mm ²	0,2 – 1,5mm ²
Stranded, H05(07) V-U min. – max.	6 – 16mm ²	0,2 – 1,5mm ²
Flexible, H05(07) V-U min. – max.	0,5 – 16mm ²	0,2 – 1,5mm ²
w. plastic collar ferrule, DIN 46228 pt 4 min. – max.	2,5 – 10mm ²	0,2 – 1,5mm ²
w. wire end ferrule, DIN 46228 pt 1, min. – max.	2,5 – 10mm ²	0,2 – 1,5mm ²
Plug gauge in accordance with EN 60999 a x b; ø	5,4 x 5,1mm; 5,3mm	2,4 x 1,5mm; 2,3mm
Pitch (P)	10,16mm	3,5mm

Wire Stripping Length (fine wired)

Nominal Cross Section	Wire End Ferrule	Stripping Length	Wire End Ferrule	Stripping Length
0,25mm ²	H0,25/5	5mm	H0,25/10 HBL	8mm
0,5mm ²	H0,5/6	6mm	H0,5/12 OR	8mm
1,0mm ²	H1,0/6	6mm	H1,0/12 GE	8mm
2,5mm ²	H2,5/12	12mm	H2,5/19D BL	14mm
4,0mm ²	H4,0/12	12mm	H4,0/20 GDR	14mm
6,0mm ²	H6,0/20	12mm	H6,0/20 SW	14mm
10,0mm ²	H10,0/12	12mm	H10,0/22 EB	15mm

The length of ferrules is to be chosen depending on the rated voltage. The outside diameter of the plastic collar should not be larger than the pitch (P)

Ordering Information

Ordering Codes

Product Code	Information	Article Number
HSEUiREG07201.018(R2)	0-18Vdc	3041084001CA
HSEUiREG07201.030(R2)	0-30Vdc	3041084002CA
HSEUiREG07201.050(R2)	0-50Vdc	3041084003CA
HSEUiREG07201.060(R2)	0-60Vdc	3041084021CA
HSEUiREG07201.090(R2)	0-90Vdc	3041084004CA
HSEUiREG07201.130(R2)	0-130Vdc	3041084005CA
HSEUiREG07201.180(R2)	0-180Vdc	3041084006CA
HSEUiREG07201.240(R2)	0-240Vdc	3041084007CA
HSEUiREG07201.018PS(R2)	PowerSink / Quick Downward Programming	3041084011CA
HSEUiREG07201.030PS(R2)	PowerSink / Quick Downward Programming	3041084012CA
HSEUiREG07201.050PS(R2)	PowerSink / Quick Downward Programming	3041084013CA
HSEUiREG07201.060PS(R2)	PowerSink / Quick Downward Programming	3041084031CA
HSEUiREG07201.090PS(R2)	PowerSink / Quick Downward Programming	3041084014CA
HSEUiREG07201.130PS(R2)	PowerSink / Quick Downward Programming	3041084015CA
HSEUiREG07201.180PS(R2)	PowerSink / Quick Downward Programming	3041084016CA
HSEUiREG07201.240PS(R2)	PowerSink / Quick Downward Programming	3041084017CA
Certificate Calibration	Separate works certificate manufacturer calibration	-
Back Plate Kit	Hart mount plate kit including screws	2201002001CA
UI.DRIVE INTERFACE	USB2.0 Interface & software download	3041093001CA



Safety regulations: Please read these instructions completely before using the equipment. Keep these instructions on to hand. The device may only be operated by trained specialist staff.

Installation:

- 1) The device is designed for devices and systems that meet the standard requirements for hazardous voltages, power, and fire prevention.
- 2.) Installation and service only by trained specialists. The AC power must be switched off. The work is to be labelled; accidental reconnection of the system must be prevented.
- 3.) Opening the device, its modification, loosening bolts, or operation outside the specified herein specification or in an unsuitable environment, has the immediate loss of warranty to follow. We disclaim any responsibility for any resulting damage to persons or things.
- 4.) Note: The device must not be operated without an upstream circuit breaker (CB). We recommend the use of B-Type 16A for 230Vac and 25A for 115Vac. It is prohibited to use the unit without PE. It may be necessary upstream device has a power switch.

Warning:

Non-compliance these warnings can result in fire and serious injury or death.

1. Never operate device without PE connection.
2. Before connecting the device to the AC network, make wires free of voltage and ensure that it cannot accidentally switch on.
3. Allow neat and professional cabling.
4. Never open nor try to repair the unit. Inside are dangerous voltages that can cause electrical shock hazard.
5. Avoid metal pieces or other conductive material to fall into the item
6. Do not operate the device in damp or wet conditions
7. Do not operate the unit under EX-conditions



All parameters after 15 minutes of continuous operation at full load / 25°C / 230Vac 50/60Hz, unless otherwise indicated.