

HPV10001 1008W Industrial Power Supply

TS35mm DIN-Rail mains supply with high output voltage

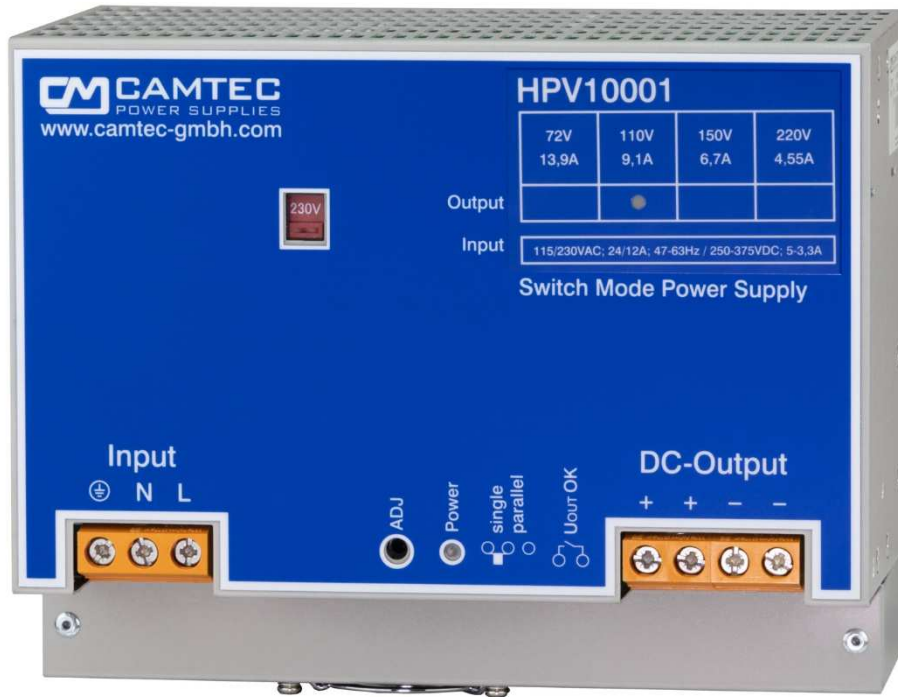

Specification:

- C/V curve down to 0V, no fold back
- Power Good Relay AC & DC-ok optional
- Efficiency up to 93%
- Hold up time >30ms
- Soft start & auto-recovery
- Precise dynamic response to load change
- Designed for long life under full stress
- Strong input filters
- High reliability, shock & vibration proof
- EMC meets CE norm class B
- Overload and short circuit protection
- Large terminals 4x AWG20 – AWG6 (0,5 – 16mm²)

Models	Voltage	Voltage setting	Current
HPV10001.072	72Vdc	58 – 86Vdc	13,9A
HPV10001.110	110Vdc	86 – 132Vdc	9,1A
HPV10001.150	150Vdc	132 – 180Vdc	6,7A
HPV10001.220	220Vdc	180 – 240Vdc	4,55A



Technical Concept

The Camtec HPV series is a high precision switch mode power supply for an upscale demand. It is engineered and manufactured by CAMTEC in Germany. The designed meets challenging applications like complex dc-drives, piezo print head, test-stands, and professional machine-building. The power supply provides a low ripple-noise, a precise load-regulation and high efficiency up to 93%. High-end long-life capacitors guarantee an extended hold-up-time and an extraordinary lifetime of the power supply. The circuit design starts complex loads easily. The internal control circuit manages illegal operating conditions to prevent your system from damages. The HPV series features active high input transients with suppressor diodes, X2-capacitors and varistors. All inputs, outputs and feature connections are galvanic isolated. The design rules set value on extended interference immunity and safety.

The unit is designed in accordance with the EN61010-1, EN61010-2-201, EN62368-1, EN60950-1 and the EMC-compatibility with EN55032.

Features

Design Conception

The HPV power supply series realizes very high-power efficiency in a space-saving housing. Latest generation electrical devices relate to the high reliability of all CAMTEC products. The CAMTEC philosophy is, to employ 125°C low ESR ultra long-life capacitors where expedient to achieve a superior lifetime of the product. The HPV power supply is made for high reliable and demanding industrial applications, railway, infrastructure, professional machine building, printing machines and complex dc-drive up to precision piezo drives.

DC-ok Power Good Relay (p.4)

The PG Relay connection indicates over temperature, low DC-voltage at the output and low AC supply voltage at the input.

Galvanic Isolation

The power supply is galvanic isolated between the input and the output. All features like the Power Good Relay are connected to the DC power outputs.

Thermal shutdown (p.5)

The HPV is featured with a thermal overload shut down and auto recovery behaviour.

Over Voltage Protection (p.5)

Ticker mode and auto recovery

Short Circuit Protection

A continuous short circuit does not cause damage to the power supply. The HPV delivers constant current and 0 output voltage. It recovers automatically after the short circuit is released.

Open Circuit Protection

The HPV series is continuously open circuit protected. The device delivers a stable output voltage and no current. If a load is immediately connected to the device, the power supply stabilizes within 1ms. It does not overshoot the output voltage.

Power Up Ramp

The devices have a soft start ramp when powering up. The device does not either overshoot the voltage nor does the output flutter – independent if a load is connected or not.

Current Voltage Chart, CV & CC mode (p.4)

The HPV series provides a perfect current voltage chart. It has no fold back or other abnormalities. The output voltage can drop down to zero volts when the power supply is overloaded. The unit delivers a stable and constant current to the outputs.

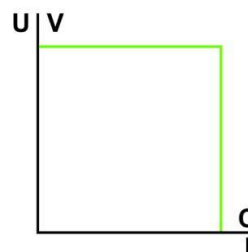

Technical Data Table

AC Input Range	90-132Vac, 184-264Vac (115/230Vac input selector, factory setting is 230Vac)			
AC Input Frequency	47-63Hz			
DC Input Range	250Vdc-375Vdc (input selector set to 230Vac)			
AC Input Rated	115Vac<17.2A 230Vac<9.8A			
DC Input Rated	250Vdc<5.0A 375Vdc<3.3A (input selector set to 230Vac rated)			
DC Voltage Rated	72Vdc	110Vdc	150Vdc	220Vdc
DC Voltage Setting Range	58 – 86Vdc	86 – 132Vdc	132 – 180Vdc	180 – 240Vdc
DC Current Rated +60°C	13,9A	9,1A	6,7A	4,55A
DC Current Rated +70°C	10,4A	6,8A	5,0A	3,4A
Power Boost 60s +60°C	15,3A	10,0A	7,4A	5,0A
Over Voltage Protection	100Vdc	154Vdc	210Vdc	310Vdc
Over Current Protection	16,0A	10,5A	7,7A	5,2A
Ripple Peak 230Vac 20MHz	200mV	250mV	300mV	400mV
Ripple RMS	71mV	88mV	106mV	141mV
Load Regulation 0-100%	< ± 0.1	< ± 0.1	< ± 0.1	< ± 0.1
Response to Load Change	<1ms 10-100%, 100-10%			
Power OK Relay (option)	Break contact, protective forced isolation to the inputs and the output 3000Vac 24Vdc/2A			
Base Load	None required (open circuit proof)			
Efficiency 230Vac	Up to 93%			
Short Circuit Protection	Continuous			
Open Circuit Proof	Continuous			
Temperature Control	Yes, thermal shutdown with auto recovery (+70°C, metering distance 50mm)			
Hold Up Time	>30ms 230Vac			
Inrush Current	NTC <162A 25°C cold start			
MCB (Circuit Breaker)	32A curve C @ 115Vac, 16A curve C @ 230Vac			
Soft Start	100ms typical			
Start-up Delay	250ms typical			
Cooling	Controlled fan from manufacturer EBM Papst (Germany)			
Ambient Operating Temp.	- 25°C...+70°C, derating 2,5%/°C >60°C			
Ambient Storage Temp.	- 40°C...+85°C			
Environment	Humidity 95% non-condensing @ 25°C, climate class. 3k3, pollution degree 2			
ROHS	2011/65/EU, (EU)2015/863			
REACH	EG No. 1907/2006			
EMI	EN55032 class B, EN61000-6-3			
EMS	EN61000-6-2			
Safety	EN61010-1, EN61010-2-201, EN62368-1, EN60950-1, EN60204-1			
Protection Class I	PE connection required			
Altitude Operations	2000m (6562 ft.) above sea level			
Creepage Distance	> 8mm			
Input to Output Isolation	3000Vac			
Input to Case Isolation	2500Vac			
Output to Case Isolation	2500Vdc			
Meantime By Failure (MTBF)	400000h (IEC61709)			
Meantime To Failure (MTTF)	127196h (IEC61709)			
Dimensions (HxWxD)	156x200x115mm			
Weight	3,2kg / 7,0lbs			
AC Input Terminals	Screw Terminal 3x AWG22 – AWG6 / 0,5 – 16mm ² (L,N,PE) tightening torque 1.2-1.5Nm, strip 4.5mm, only copper conductors			
DC Output Terminals	Screw Terminal 4x AWG22 – AWG6 / 0,5 – 16mm ² (+/- -) tightening torque 1.2-1.5Nm, strip 4.5mm, only copper conductors			

Manual and Technical Details

Technical Data Table - Analogue Interface & Voltage Setting

Feature	Technology	Details and Connections	Section	Isolation
Potentiometer Voltage	1 turn	High precision	U adj	3000Vac to input & output
Power Good Relay	"b" contact	AWG24 – AWG14 / 0,25 – 2,5mm ²	DC-ok	3000Vac to input & output

The potentiometer and the optional power good relay provide a forced isolation. It is to ensure a protective isolation for the 240Vdc.

DC Voltage setting range

Rated DC Voltage	72Vdc	110Vdc	150Vdc	220Vdc
Rated DC Current	13,9A	9,1A	6,7A	4,55A
DC Voltage Setting Range	58 – 86Vdc	86 – 132Vdc	132 – 180Vdc	180 – 240Vdc

The DC voltage can be adjusted with a precision 1 turn potentiometer with low temperature fading. The factory setting is to the rated voltage from the table above.

Optional DC-OK Relay (PG-Option)

The DC ok relay indicates if the output voltage is low and if the AC voltage is low. The contact is galvanic insulated to the AC input and the DC output connections. The isolation is 3000Vac with a forced isolation and covers the overall adjustment range of the HPV model with 220Vdc. If the DC voltage is ok the relay is closed, if the power supply unit is in false operation the relay is open. Considering the lower and the upper margin of the AC voltage detection it is to say that the HPV series starts at 85Vac/150Vac depending on the AC input selector. The unit starts with 200Vdc when a DC voltage applies to the input. Make sure to set the AC input selector to 230Vac (factory setting) for DC input supply.

DC-Fail hysteresis: drop-out 15% V_{nominal} / pull-in 50% V_{nominal}. Contact Rating 24Vdc/2A, 30Vac/6A.

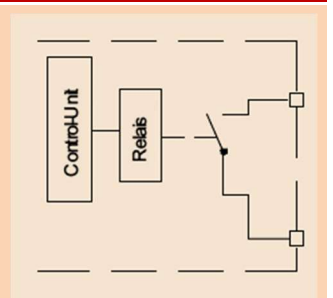

DC OK Indication

Power Supply Status	Normal	Over Temperature	AC Low [V]	DC Low [V]
Relay Operation status	Closed	Open	Open	Open

C/V Current Voltage Behaviour

The HPV series provides a perfect current voltage chart. It has no fold back or other abnormalities. The output voltage can drop down to zero volts when the power supply is overloaded. The unit delivers a stable and constant current to the outputs.

When the output voltage is set to the maximum demanded value and the current limit circuit acts, the output voltage drops linear down to zero and the unit delivers constant current.

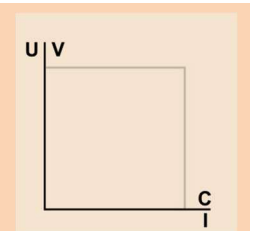

Overtemperature Thermal Shutdown, Over Voltage Protection & Derating

OT Over Temperature The maximum ambient temperature is +70°C. If the power supply exceeds this value (over temperature protection) it completely shuts down (metering point 50mm from outside device). The device restarts automatically into operation when the temperature drops to a normal value.

OVP Over Voltage Protection Exceeding the OVP results in a locked shutdown mode. Resuming the failure causes automatic restart into normal operation. For the values, please read the Technical Table on page 3.

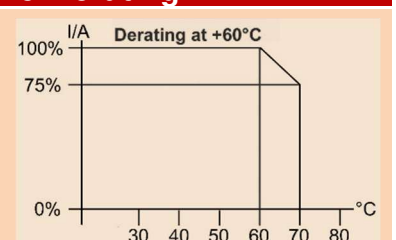

Baseplate Cooling & Temperature Management

The temperature management of the HPV series provides a direct dissipation of the main energy losses. The internal coolers of the output diodes and the power FETs connect to the back-plate cooler. It is possible to dissipate about 40 – 50% of the energy losses out of a system to a plane and heat conductive surface. For further information please consult our technical support.

Parallel Operation & Decoupling

To increase the output power N+1 of the HPV units, two or more devices of the same model with the same output voltage can be parallel connected. Advise using busbars to connect several devices in parallel. Always use identical cabling length and identical cross sections to the busbar or a star point. Allow proper connection for low contact resistance. The output voltage of each involved power supply units must be adjusted 100% equal. Set the indicated switcher at the bottom of the power supply from “single” (factory pre-set) to “parallel” operation. The C/V characteristic line will slightly ream. The power-output distribution between the involved units will be more accurate.

The HPV models have no internal O-ring diode. For decoupling the devices N+1, up to 125Vdc, we recommend using our RED00202 DIN rail diode module. It is capable to decouple 2pcs of the HPV power supplies from each other. To increase the power capability RED models can be connected in parallel. For higher voltages, an external decoupling diode shall be installed from the system engineer.

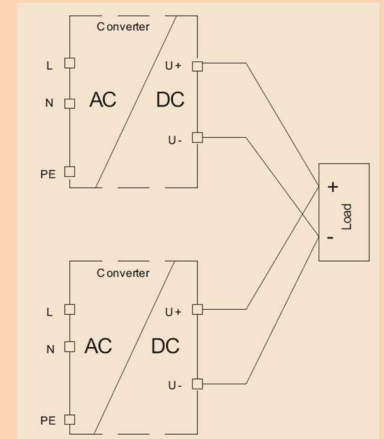

Coating Option

We offer the HPV series with an optional coating. It is to be used in e.g. dusty, dirty, high humidity area or in awaiting quick temperature changes. Short circuit and corrosion at print board lines and at solder points can be prevented. The coat itself is a transparent acrylic resin.

Peters SL 1306 N-FLZ (transparent) IEC60216-1 2001, IPC-CC-830B, UL listed as permanent coating
File No.: E80315 , UL94V-0

Electrical Safety (Factory-Test / Field-Test Owner)

	T	A	B	C	D	E
Type Test	60s	2500Vac	3000Vac	2500Vdc	3000Vac	500Vdc
Factory Test	5s	2000Vac	2000Vac	2500Vdc	2000Vac	500Vdc
Field Test	2s	2000Vac	2000Vac	2500Vdc	2000Vac	500Vdc
Cut-off current setting	>20mA	>20mA	>1mA	>1mA	>1mA	>1mA

Type and factory test are the manufacturer. While repeating damage can happen to the power supply unit. For the field test (owner) follow the below instruction:

- Use suitable test equipment, raising the voltage slowly
- Short circuit L1 and N, and all the DC output terminals.
- Use only test voltages of 50/60Hz. The outputs are unearthed and therefore they have no resistance to GND/PE.
- If the residual voltage is ≥ 60 Vdc, observe the safety standards. Use only specially insulated screwdriver to trim the Ua/la.

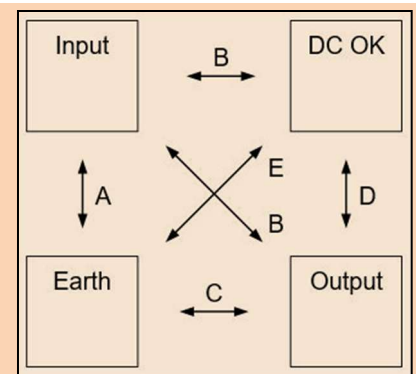

Mechanics

Mechanics

Stable metal/aluminum housing IP20. To allow adequate convection, a free air space of 50mm (top/bottom) and 10mm (sidewalls) is required; for active devices 15mm space from the sidewalls. For free air convection it is necessary to install the unit horizontal. Use the DIN-Rail installation (equipped standard) with the patented 35mm DIN-Rail brackets according to EN60715. It is easy to mount/dismount while snapping it onto the 35mm DIN-Rail - no tools are necessary. A hard mount backplate (option) is available as well.

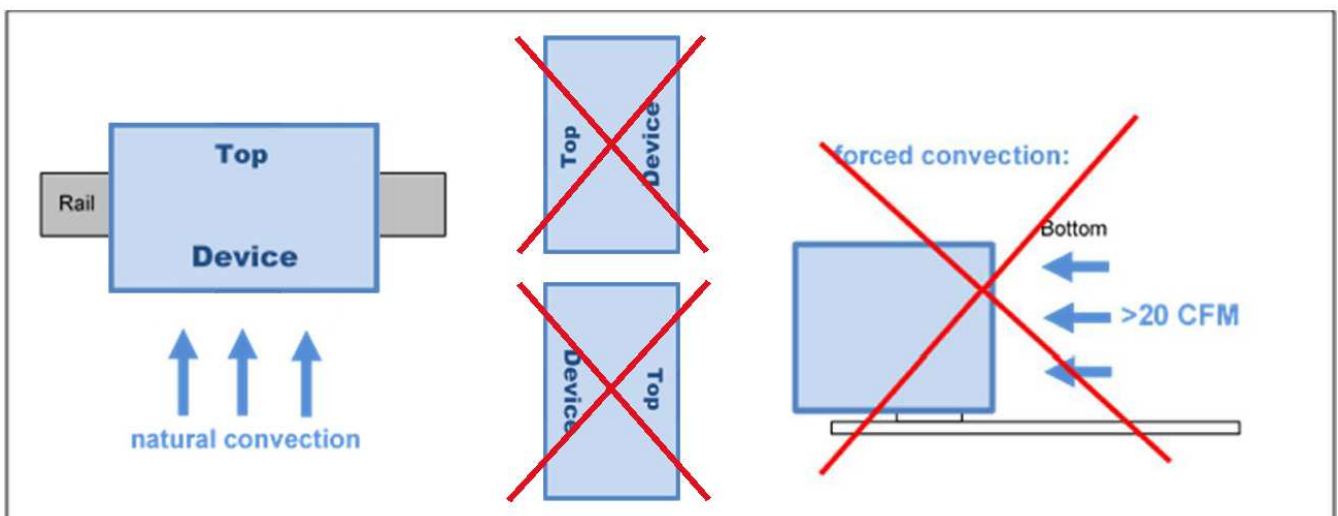
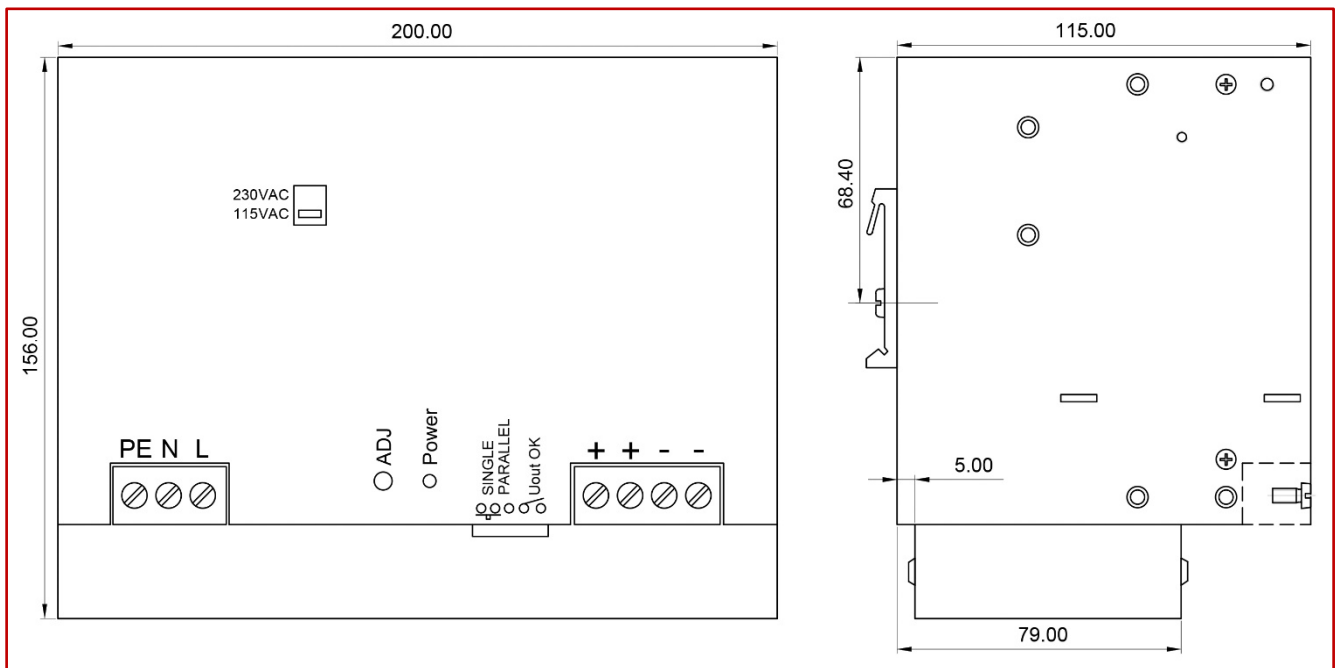

Mounting Instruction: recommended airflow space below and above is 50mm (2 Inch)

Mechanics & Installation Instruction of the HPV10001

Stable metal/aluminum housing IP20. To allow adequate convection, a free air space of 50mm (top/bottom) and 10mm (sidewalls) is required; and for active devices 15mm space from the sidewalls. For proper air convection it is necessary to install the HPV10001. One can use the DIN-Rail installation (equipped standard) with our patented 35mm DIN-Rail bracket according to EN60715. It is easy to mount/dismount while snapping it onto the 35mm DIN-Rail - no tools necessary. A wall mount back plate (option) is available, too.

It is not allowed to install the HPV10001 in other mounting direction then as shown in the drawings.

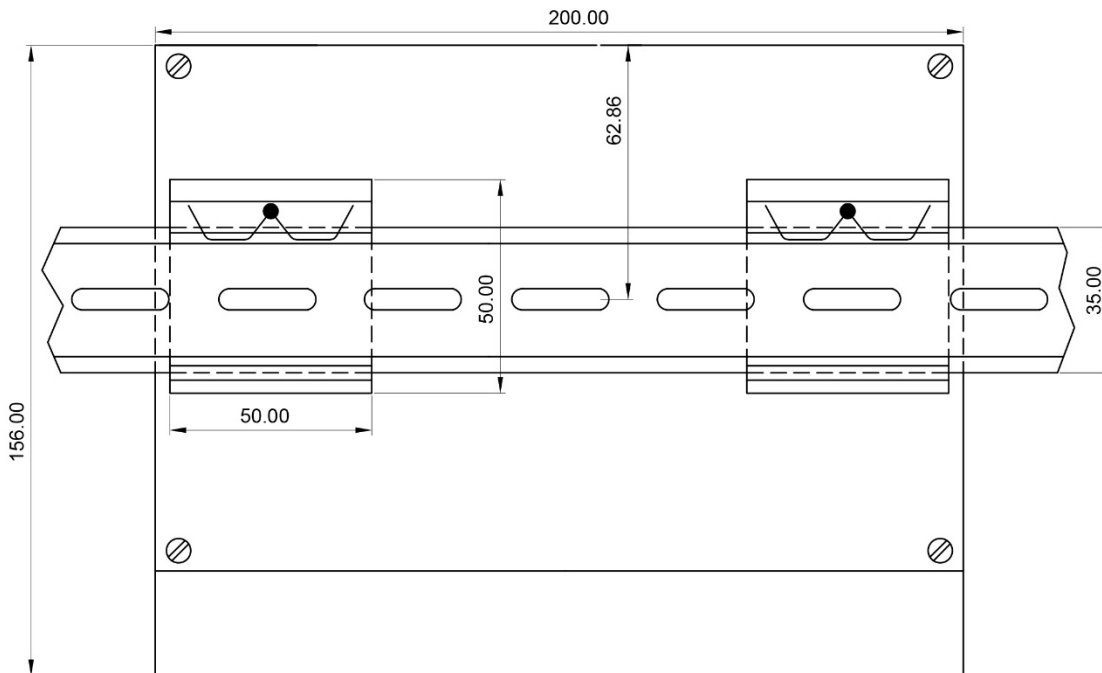

Back Plate Option / DIN-Rail Standard

(The HPV10001 is always delivered for DIN-rail mount, the back-plate is an optional part that shall be mounted from the customer. The threads from the DIN-rail mounting brackets shall be used. All screws are included into the Back-Plate Kit.)

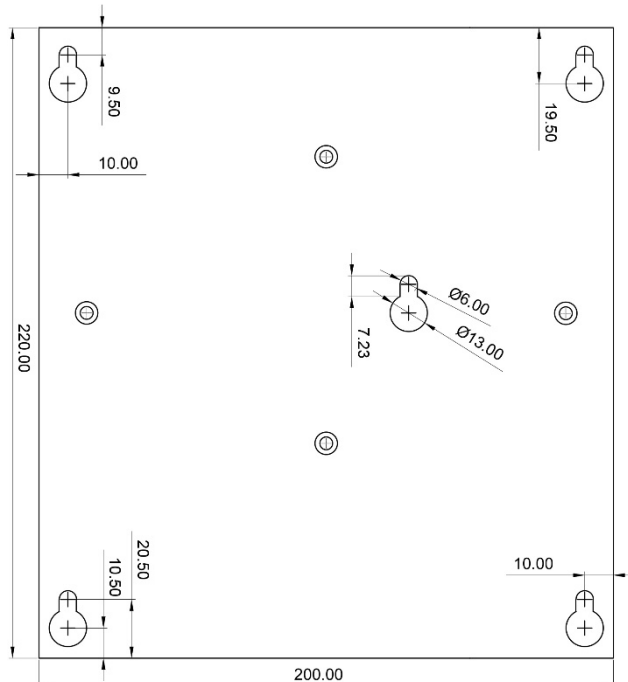

Connections

Clamping Yoke Connector Specifications

	Input / Output connections	Power OK connection plug
Tightening torque min. – max.	1,2 – 2,2Nm (blade 1,0x5,5 DIN5264)	0,2 – 0,25Nm (blade 0,4x2,2 DIN5264)
Touch-safe protection acc. to DIN VDE 0470	IP20 plugged/ IP10 unplugged	Not applicable
Clamping range, min. – max.	0,5 – 16mm ² / AWG26 – AWG6	0,2 – 1,5mm ² / AWG28 – AWG14
Solid, H05(07) V-U min. – max.	0,5 – 16mm ²	0,2 – 1,5mm ²
Stranded, H05(07) V-U min. – max.	6 – 16mm ²	0,2 – 1,5mm ²
Flexible, H05(07) V-U min. – max.	0,5 – 16mm ²	0,2 – 1,5mm ²
w. plastic collar ferrule, DIN 46228 pt 4 min. – max.	2,5 – 10mm ²	0,2 – 1,5mm ²
w. wire end ferrule, DIN 46228 pt 1, min. – max.	2,5 – 10mm ²	0,2 – 1,5mm ²
Plug gauge in accordance with EN 60999 a x b; ø	5,4 x 5,1mm; 5,3mm	2,4 x 1,5mm; 2,3mm
Pitch (P)	10,16mm	3,5mm

Wire Stripping Length (fine wired)

Nominal Cross Section	Wire End Ferrule	Stripping Length	Wire End Ferrule	Stripping Length
0,25mm ²	H0,25/5	5mm	H0,25/10 HBL	8mm
0,5mm ²	H0,5/6	6mm	H0,5/12 OR	8mm
1,0mm ²	H1,0/6	6mm	H1,0/12 GE	8mm
2,5mm ²	H2,5/12	12mm	H2,5/19D BL	14mm
4,0mm ²	H4,0/12	12mm	H4,0/20 GDR	14mm
6,0mm ²	H6,0/20	12mm	H6,0/20 SW	14mm
10,0mm ²	H10,0/12	12mm	H10,0/22 EB	15mm

The length of ferrules is to be chosen depending on the rated voltage. The outside diameter of the plastic collar should not be larger than the pitch (P)

Ordering Information

Ordering Codes

Product Code	Information	Power ok Relay	Article Number
HPV10001.072(R2)	72V	No	3041076001CA
HPV10001.110(R2)	110V	No	3041076002CA
HPV10001.150(R2)	150V	No	3041076003CA
HPV10001.220(R2)	220V	No	3041076004CA
HPV10001.072PG(R2)	72V	Yes	3041076201CA
HPV10001.110PG(R2)	110V	Yes	3041076202CA
HPV10001.150PG(R2)	150V	Yes	3041076303CA
HPV10001.220PG(R2)	220V	Yes	3041076104CA
Back Plate Kit	Base Plate / Hart mount plate kit including screws	-	2201002001CA



Safety regulations: Please read these instructions completely before using the equipment. Keep these instructions on to hand. The device may only be operated by trained specialist staff.

Installation:

- 1) The device is designed for devices and systems that meet the standard requirements for hazardous voltages, power, and fire prevention.
- 2.) Installation and service only by trained specialists. The AC power must be switched off. The work is to be labelled; accidental reconnection of the system must be prevented.
- 3.) Opening the device, its modification, loosening bolts, or operation outside the specified herein specification or in an unsuitable environment, has the immediate loss of warranty to follow. We disclaim any responsibility for any resulting damage to persons or things.
- 4.) Note: The device must not be operated without an upstream circuit breaker (CB). We recommend the use of C-Type 16A for 230Vac or 32A for 115Vac. It is prohibited to use the unit without PE. It may be necessary upstream device has a power switch.

Warning:

Non-compliance these warnings can result in fire and serious injury or death.

1. Never operate device without PE connection.
2. Before connecting the device to the AC network, make wires free of voltage and ensure that it cannot accidentally switch on.
3. Allow neat and professional cabling.
4. Never open nor try to repair the unit. Inside are dangerous voltages that can cause electrical shock hazard.
5. Avoid metal pieces or other conductive material to fall into the item
6. Do not operate the device in damp or wet conditions
7. Do not operate the unit under EX-conditions



All parameters base on 15 minutes run-in @ full load / 25°C / 230Vac 50/60Hz, as otherwise stated.