

CPS-EC1500

1500W Precision DC Rectifier

DIN-Rail Battery Charger, A/V Adjustable Industrial Power

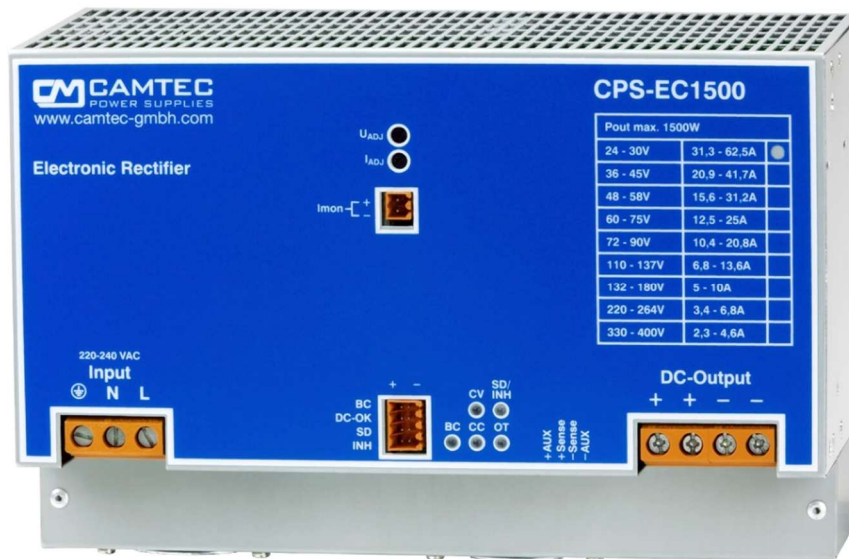

Specification:

- Real time output current monitoring
- Precision potentiometer f. voltage & current
- Power Good Relay AC & DC-ok
- C/V curve down to 0V, no fold back
- Sense control 2V per load line
- Electronic inrush current limiter 20,7Apeak
- Inhibit function (Interlock)
- External shutdown
- Boost Charge Mode
- Precise dynamic response to load change
- Designed for long life under full stress
- Strong input filters
- Hold up time >20ms
- High reliability, shock & vibration proof
- Overload and short circuit protection
- Efficiency up to 94%
- EMI/EMS EN61000-6-2,3, EN55032
- EN61010-1, EN61010-2-201, EN62368-1

Models	Voltage	Voltage setting	Current setting
CPS-EC1500.024	24Vdc	24 – 30Vdc	31,3 – 62,5A
CPS-EC1500.036	36Vdc	36 – 45Vdc	20,9 – 41,7A
CPS-EC1500.048	48Vdc	48 – 58Vdc	15,6 – 31,2A
CPS-EC1500.060	60Vdc	60 – 75Vdc	12,5 – 25,0A
CPS-EC1500.072	72Vdc	72 – 90Vdc	10,4 – 20,8A
CPS-EC1500.110	110Vdc	110 – 137Vdc	6,8 – 13,6A
CPS-EC1500.150	150Vdc	132 – 180Vdc	5,0 – 10,0A
CPS-EC1500.220	220Vdc	220 – 264Vdc	3,4 – 6,8A
CPS-EC1500.400	400Vdc	330 – 400Vdc	2,3 – 4,6A



Technical Concept

The Camtec CPS-EC series is a high precision switch mode power supply for an upscale demand. The unit is C/V adjustable. It is engineered and manufactured by CAMTEC in Germany. The designed meets challenging applications like railway, complex drives, battery charging for DC-UPS, test-stands, machine-building and professional LED lighting. The power supply provides a low ripple-noise, a precise load-regulation and high efficiency up to 94%. High-end long-life capacitors guarantee an extended hold-up-time and an extraordinary lifetime of the power supply. The circuit design starts complex loads easily. The internal control circuit manages illegal operating conditions to prevent your system from damages. The CPS-EC series features active high input transients with suppressor diodes, X2-capacitors and varistors. All inputs, outputs and feature connections are galvanic isolated. The design rules set value on extended interference immunity and safety. The unit is designed in accordance with the EN60950-1, EN62368-1, EN61010-1, EN61010-2-201 and the EMC-compatibility with EN55032.

Features

Design Conception

The CPS-EC power supply series realizes very high-power efficiency in a space-saving housing. Latest generation electrical devices relate to the high reliability of all CAMTEC products. The CAMTEC philosophy is, to employ 125°C low ESR ultra long-life capacitors where expedient to achieve a superior lifetime of the product. The CPS-EC power supply is made for high reliable and demanding industrial applications, railway, unbreakable power supply charger (DC-UPS), professional high-power lighting (floodlight, production hall) and for telecom & demanding IT applications.

Voltage Setting Potentiometer

The output voltage limit can be adjusted with a 15 turns high precision potentiometer. The listed values are guaranteed by the factory. The tolerance of the upper margin is -0/+5%. The tolerance of the lower margin is -5%/+0%. The output voltages cover the typical cell voltage range of standard lead acid batteries.

Current Setting Potentiometer

The output current limit can be adjusted with a 15 turns high precision potentiometer. The listed values are guaranteed by the factory. The tolerance of the upper margin is -0/+5%. The tolerance of the lower margin is -5%/+0%.

Output Current Monitoring

The CPS-EC power supply features a 0-5Vdc signal output. It is a real-time linear signal and indicates the current consumption of the load. The measuring point is directly at the output connection of the device.

Boost Charge Mode

The CPS-EC1500 offers a boost charge mode. The defined current limiting can be triggered from an external signal to increase for 10% the set value.

Sensing

The device has a sense operation mode to compensate a voltage drop at the load line.

Inhibit contact (Interlock)

The inhibit inputs can be connected to a safety contact or a safety relay. When the contact is open the power supply will remain in a completely locked shut down mode. The unit powers up as soon as the contact is closed.

Remote Shutdown feature

All CPS-EC units are featured with a shutdown (switch/open collector).

DC-ok Power Good Relay

The PG Relay connection indicates over temperature, low DC-voltage at the output, low AC supply voltage at the input, inhibit and the shutdown mode.

Galvanic Isolation

The power supply is galvanic isolated between the input and the output. All features like Shut Down, Inhibit and the Power Good Relay are isolated from the DC-power outputs and the sense connections. Sensing and the Current Monitoring are connected to the DC power outputs.

Thermal shutdown

The CPS-EC series is featured with a thermal overload shut down and auto recovery behavior.

Over Voltage Protection

Ticker mode and auto recovery.

Short Circuit Protection

A continuous short circuit does not cause damage to the power supply. The CPS-EC delivers constant current and 0 output voltage. It recovers automatically after the short circuit is released.

Open Circuit Protection

The CPS-EC series is continuously open circuit protected. The device delivers a stable output voltage and no current. If a load is immediately connected to the device, the power supply stabilizes within 1ms. It does not overshoot the output voltage.

Power Up Ramp

The devices have a soft start ramp when powering up. The device does not either overshoot the voltage nor does the output flutter – independent if a load is connected or not.

Inrush Limiter

The power supply provides an electronic inrush current limiter that works absolute accurately with a low inrush of only 14,7A RMS value. The limiter works independent from the ambient temperature and its tolerance is only ±10%.

Current Voltage Chart, CV & CC mode

The CPS-EC series provides a perfect current voltage chart. It has no fold back or other abnormalities. The output voltage can drop down to zero volts when the power supply is overloaded. The unit delivers a stable and constant current to the outputs. The device can be used either in the CV or in the CC mode (auto switch).

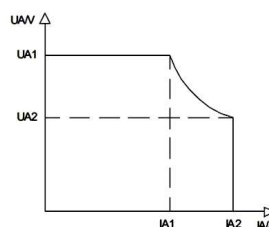

Technical Data Table

AC Input Range	184 – 264Vac , 47 – 63Hz								
DC Input Range	250Vdc – 375Vdc								
AC Input Rated	230Vac<13,5A								
DC Input Rated	250Vdc<7,5A 375Vdc<5,0A								
DC Output Voltage Rated	24Vdc	36Vdc	48Vdc	60Vdc	72Vdc	110Vdc	150Vdc	220Vdc	400Vdc
DC Voltage Setting Range	24 – 30Vdc	36 – 45Vdc	48 – 58Vdc	60 – 75Vdc	72 – 90Vdc	110 – 137Vdc	132 – 180Vdc	220 – 264Vdc	330 – 400Vdc
DC Current Setting Range	31,3 – 62,5A	20,9 – 41,7A	15,6 – 31,2A	12,5 – 25,0A	10,4 – 20,8A	6,8 – 13,6A	5,0 – 10,0A	3,4 – 6,8A	2,3 – 4,6A
Over Voltage Protection	34Vdc	50Vdc	67Vdc	84Vdc	100Vdc	154Vdc	210Vdc	310Vdc	450Vdc
Over Current Protection	62,5A	41,7A	31,2A	25,0A	20,8A	13,6A	10,0A	6,8A	4,6A
Ripple Noise 230Vac 20MHz	40mV	80mV	120mV	150mV	200mV	300mV	400mV	400mV	400mV
Ripple RMS	14mV	28mV	42mV	53mV	71mV	106mV	141mV	141mV	141mV
Power Rated	1500W, 184-264Vac								
Potentiometer C/V Setting	15 turns high precision, protective forced isolation to the inputs and the output 3000Vac								
Operation Failure Relay	Yes, break contact, protective forced isolation to the inputs and the output 3000Vac								
Sense Function	Compensation 2V per load line								
Remote Shutdown	Yes, protective forced isolation to the inputs and the output 3000Vac								
Inhibit Function (Interlock)	Yes, protective forced isolation to the inputs and the output 3000Vac								
Derating	+60°C...+70°C 2.5%/°C								
Interface Accuracy Imon	< ± 1.5%								
Interface Latency Imon	< 0.1ms on signal change								
Load Regulation	< ± 0.05% 0-100%								
Start up from Shutdown	Typ. 420ms								
Start up from Inhibit	Typ. 420ms								
Response to Load Change	<1ms 10-100%, 100-10%								
Base Load	None required (open circuit proof)								
Efficiency 230Vac	92-94% at 90% load								
Short Circuit Protection	Continuous								
Open Circuit Proof	Continuous								
Temperature Control	Yes, thermal shutdown with auto recovery (+70°C, metering distance 50mm)								
Hold Up Time	>20ms 230Vac								
Inrush Current ±5%	<14,7Aeff <20,7Apeak (230Vac) active inrush current limiter								
MCB (Circuit Breaker)	16A type B								
Soft Start	100ms typical								
Cooling	Controlled and stepless fans from manufacturer EBM Papst (Germany)								
Ambient Operating Temp.	- 25°C...+70°C								
Ambient Storage Temp.	- 40°C...+85°C								
Environment	Humidity 95% non-condensing @ 25°C, climate class. 3k3, pollution rate II								
ROHS	2011/65/EU, (EU)2015/863								
REACH	EG No. 1907/2006								
EMI	EN55032 conducted class B, radiated class A, EN61000-6-3								
EMS	EN61000-6-2								
Safety	EN61010-1, EN61010-2-201, EN62368-1 (not 400Vdc model), EN60950-1, EN60204-1								
Protection Class 1	PE connection required								
Isolation Paths	> 8mm creepage distance & clearance paths								
Input to Output Isolation	3000Vac								
Input to Case Isolation	2500Vac								
Output to Case Isolation	500Vdc , models ≥48Vdc=2800Vdc								
MTBF (IEC61709)	400000h (Mean Time Between Failures: statistic time between failures after repairs)								
MTTF (IEC61709)	144006h (Mean Time To Failure: statistic time to ever fails)								
Dimensions (HxWxD)	161x250x119.5mm								
Weight	4,1kg / 9,0lbs								
AC Terminals	Input Screw Terminal 3x AWG22 – AWG6 / 0,5 – 16mm ² (L,N,PE)								
DC Terminals	Output Screw Terminal 4x AWG22 – AWG6 / 0,5 – 16mm ² (+ / - -)								

Manual and Technical Details

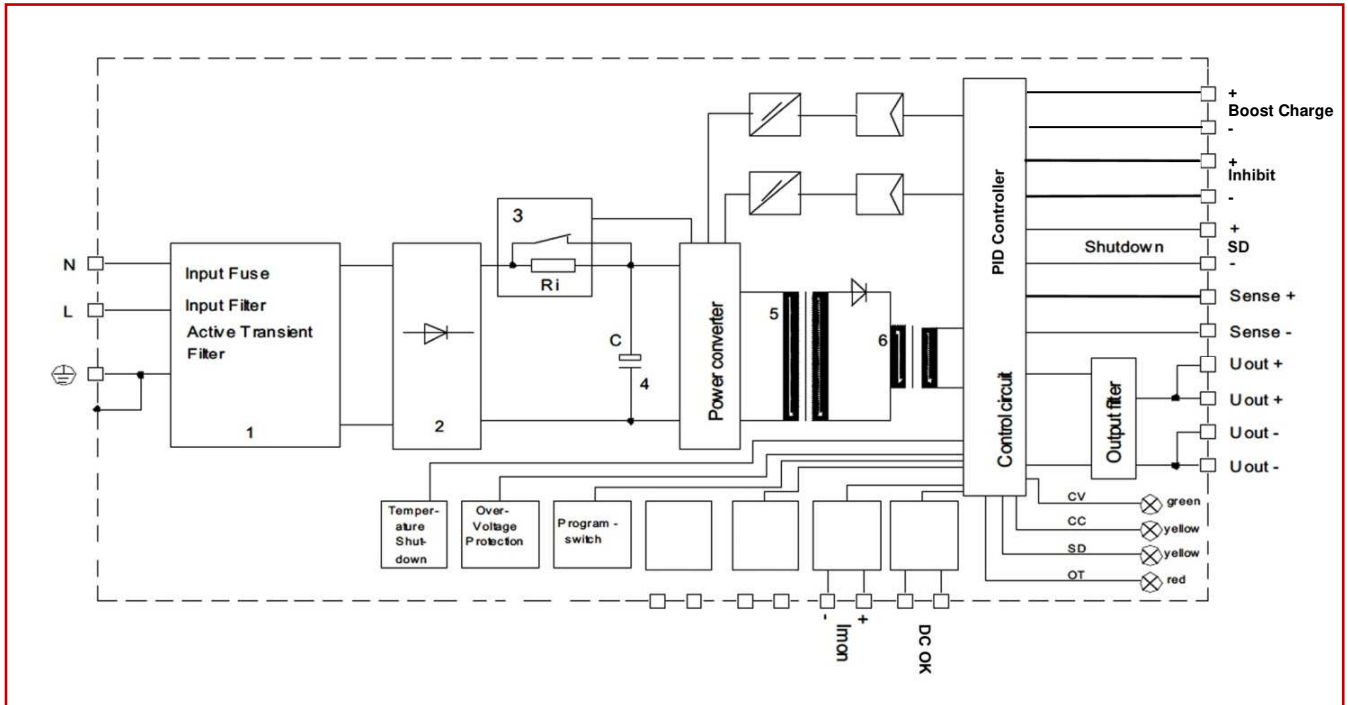

1) Active Transient Filter 2) Rectifier 3) Inrush Current Limiter 4) Load Capacitor 5) Power Transformer 6) Storage Choke
 LED: CV = constant voltage operation CC = constant current operation SD/INH = shutdown / inhibit OT = temperature failure >70°C

Technical Data Table - Analogue Interface & Voltage Current Control

Feature	Technology	Details and Connections	Section	Isolation
Potentiometer Voltage	15 turns	High precision	U adj	3000Vac to input & output
Potentiometer Current	15 turns	High precision	I adj	3000Vac to input & output
Monitoring Current	0...5Vdc/5mA	AWG22 – AWG6 / 0,25 – 1,5mm ²	I mon	3000Vac to input
Shutdown	Open Collector *	AWG22 – AWG6 / 0,25 – 1,5mm ²	SD	3000Vac to input & output
Inhibit (Interlock)	Open Collector *	AWG22 – AWG6 / 0,25 – 1,5mm ²	Inhibit	3000Vac to input & output
Sense Compensation	1V per load line	AWG22 – AWG6 / 0,25 – 1,5mm ²	Sense & Aux	3000Vac to input
Boost Charge	Open Collector *	AWG22 – AWG6 / 0,25 – 1,5mm ²	BC	3000Vac to input & output
Power Good Relay	"b" contact	AWG22 – AWG6 / 0,25 – 1,5mm ²	DC-OK	3000Vac to input & output

*can also be used with a simple passive switch

All potentiometers and all the inputs and the outputs of the analogue interface provide a forced isolation. It is to ensure a protective isolation for the 400Vdc.

DC Voltage & Current adjustment range

Rated DC Voltage	24Vdc	36Vdc	48Vdc	60Vdc	72Vdc	110Vdc	150Vdc	220Vdc	300Vdc
DC Voltage Setting Range	24 – 30Vdc	36 – 45Vdc	48 – 58Vdc	60 – 75Vdc	72 – 90Vdc	110 – 137,5Vdc	132 – 180Vdc	220 – 264Vdc	330 – 400Vdc
DC Current Setting Range	31,3 – 62,5A	20,9 – 41,7A	15,6 – 31,2A	12,5 – 25,0A	10,4 – 20,8A	6,8 – 13,6A	5,0 – 10,0A	3,4 – 6,8A	2,3 – 4,6A

The DC voltage and the current can be adjusted with a high precision 15 turn potentiometer with low temperature fading. The factory setting is to the rated voltage & current from the table above. Due to the tolerances of the potentiometers, the lower margin of the output voltage can be adjusted below the upper threshold margin of the DC Power Good Relay (see p.6). To ensure a proper operation, the DC voltage setting

CPS-EC1500(R2) MANUAL

must stay above the upper hysteresis level of the Power Good Relay. We guarantee the above given adjustment ranges with a tolerance of -5/0% for the lower margin and 0/+5% for the upper margin.

Monitoring of the Output Current Consumption

The Current Monitor I_{mon} output is buffered with OP-amplifiers, pre-resistors & parallel connected Zener diodes. The monitor output delivers 0-5Vdc 5mA control voltage. The signal is absolute proportional to the adjusted output current. The signal is real time, and the measuring point is exactly at the DC outputs of the power supply unit. The monitoring is directly connected with the DC power outputs.

Sensing (Load Line Compensation)

The CPS-EC provides a sensing function to compensate a voltage drop from the load lines. The maximum compensation is 2V. Be aware that this operation mode may recommend extended preparations concerning interference elimination. If the sensing feature is not used the S +/- must be connected to AUX +/- with very short wires (factory setting).

To use the sensing feature, please disconnect the local sensing wires from the AUX +/- and the S +/- connections. Connect the sense lines to the load. Make sure that +/- connections are matching!

WARNING! Reverse polarity of the sense lines can cause damages to the power supply unit.

To basically prevent from interferences, enable to twist sense compensation lines. To reduce inductive influences, make sure that the load wires are installed close to each other. Driving a pulsative load requires a large electrolytic and a ceramic capacitor. Make sure that C1 & C2 are not oscillating with load wires. It would cause ripple voltage into the load lines. The internal over voltage protection (OVP) controls the output voltage directly at the DC output connections. It opens automatically in case of a failure from the DC source (see OVP table).

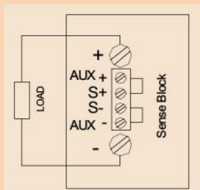

Local Sensing
(factory setting)

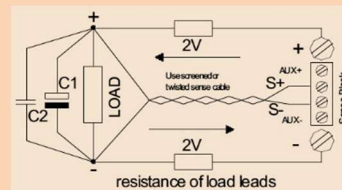

Remote Sensing
(twist wires)

Remote Sensing with Battery Charger

When using the CPS-EC as a battery charger please avoid the remote sensing operation mode. It may cause serious damage to the unit when the battery connections are being mixed up. If you really need to install a remote sensing apply to the below figure circuit. Good values are 250mA for the Si fuses and 3...5A capability for the diodes.

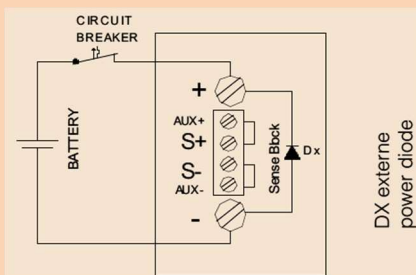

DX externe
power diode

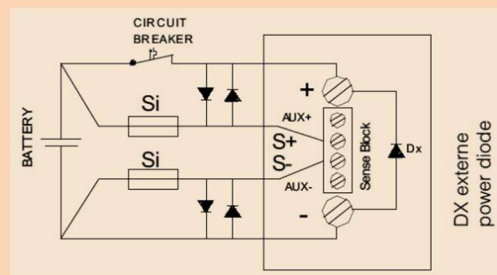

DX externe
power diode

Inhibit (Interlock)

The inhibit inputs can be connected to a safety contact or a safety relay. When the contact is open the power supply will remain completely locked in a shutdown mode. The unit powers up immediately when the connection is closed. The current through the inhibit connection is typically 2mA.

CPS-EC1500(R2) MANUAL

WARNING! It is prohibited to apply an external voltage to the inhibit connection! The CPS-EC unit can be seriously damaged! Always use passive mechanical contacts from switchers or relays. Between control input INH, power input and power output is a reinforced Isolation of max. 400Vdc.

Shutdown

All CPS-EC units are featured with an external shutdown (switch/open collector). When the connection is open the power-supply operates. When the connection is closed the power supply goes into a standby mode (short-circuited). The power supply powers up as soon as the shutdown connections is opened. The signal through the connections is 1Vdc max. . The shutdown connections have an internal pull-up resistor with 4700 Ω at the plus line (max. +12V inserted).

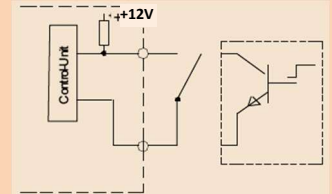

Boost Charge

The CPS-EC1500 features a boost charge mode (switch/open collector). When the connection is open the power-supply operates the set current. When it is closed (short-circuited) the power supply delivers +10% current boost. The overall power of 1500W cannot be exceeded. The boost charge is no power-boost, and it is recommended to set the current limiting to $\leq 90\%$. The factory set is 100%. The boost charge releases as soon as the connection is opened. The signal through the connection is 1Vdc max. . The boost charge connections have an internal pull-up resistor with 4700 Ω at the plus line (max. +12V inserted).

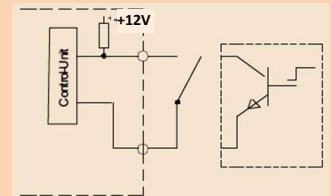

DC-OK (Power Good Relay)

The DC ok relay indicates if the output voltage is low and if the AC voltage is low. The contact is galvanic insulated to the AC input and the DC output connections. The isolation is 3000Vac with a forced isolation and covers the overall adjustment range of the CPS-EC series up to 400Vdc. If the DC voltage is ok the relay is closed, if the power supply unit is in false operation, in the shutdown or in the inhibit mode, the relay is open. Considering the lower and the upper margin of the AC voltage detection it is to say that the CPS-EC series starts at 150Vac. The unit starts with 210Vdc when a DC voltage applies to the input.

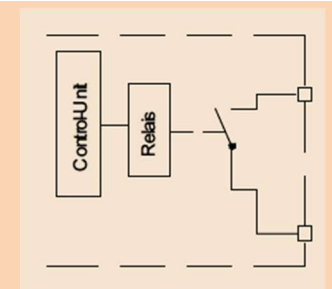

The below table of values shows the hysteresis of the lower and upper threshold margins where the DC OK Relay indicates a low voltage. The nominal voltage of the cell voltage of a typical lead acid battery VRLA & vented GEL & AGM is listed (OPsZ, OPzS, OPzV, OGi, OGiV, GiV types). **WARNING!** Regarding the DC-output voltage setting range it is important to consider that this data sheet shows the guaranteed values. In practice the range will be wider and with some models the lower margin of the setting range will be below the DC ok high margin of the DC-ok relay. Make sure that the output voltage setting will properly stay above the DC ok high margin to avoid false messages from the relay. ^

Hysteresis & Threshold Margins

Model	Nominal [V]	DC ok low	DC ok high	No. of Cells	Nominal Cell [V]	Input ok low	Input ok high
CPS-EC1500.024	24V	21,6Vdc	22,8Vdc	12	26,76 – 28,80Vdc	140Vac 175Vdc	150Vac 210Vdc (the power supply unit starts at 150Vac/210Vdc)
CPS-EC1500.036	36V	32,4Vdc	34,2Vdc	18	40,14 – 43,20Vdc		
CPS-EC1500.048	48V	43,2Vdc	45,6Vdc	24	53,52 – 57,60Vdc		
CPS-EC1500.060	60V	54,0Vdc	57,0Vdc	30	66,90 – 72,00Vdc		
CPS-EC1500.072	72V	64,8Vdc	68,4Vdc	36	80,28 – 86,40Vdc		
CPS-EC1500.110	110V	99,0Vdc	104,5Vdc	54	120,42 – 129,60Vdc		
CPS-EC1500.150	150V	118,8Vdc	125,4Vdc	-	-		
CPS-EC1500.220	220V	198,0Vdc	209,0Vdc	108	240,84 – 259,20Vdc		
CPS-EC1500.400	400V	297,0Vdc	313,5Vdc	165	367,95 – 396,00Vdc		

DC OK Indication

Power Supply Status	Normal	Low [V]	Over Temperature	Shut Down Closed	Inhibit Open
---------------------	--------	---------	------------------	------------------	--------------

CPS-EC1500(R2) MANUAL

Relay Operation status	Closed	Open	Open	Open	Open
------------------------	--------	------	------	------	------

LED Signal Indication

LED	Low [V]	Over [V]	Over Temp.	Inhibit Open	Shut Down	Constant [V]	Constant [C]	Boost Charge
CV	OFF	OFF	OFF	OFF	OFF	ON	OFF	ON
CC	OFF	OFF	OFF	OFF	OFF	OFF	ON	OFF
OT	OFF	OFF	ON	OFF	OFF	OFF	OFF	OFF
BC	OFF	OFF	OFF	OFF	OFF	OFF	OFF	ON
SD/INH	OFF	OFF	OFF	ON	ON	OFF	OFF	OFF

C/V Chart and Operating Point

The CPS-EC series provides a perfect current voltage chart. It has no fold back or other abnormalities. The output voltage can drop down to zero volts when the power supply is overloaded. The unit delivers a stable and constant current to the outputs. The device can be used either in the CV or in the CC mode (automatic switch over). When the output voltage is set to the maximum demanded value and the current limit reaches its desired margin, the output voltage drops down and the unit delivers constant current. Similar is when the upper margin of the voltage allows the current to be dropped by the power reduction behavior of the CPS-EC series. The C/V setting must meet the $P_{max} = 1500W!$

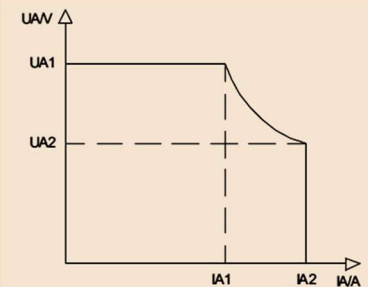

Model	Value UA1 (V)	Value IA1 (A)	Value UA2 (V)	Value IA2 (A)	Pmax
CPS-EC1500.024	30	50,0	24	62,5	1500/1500W
CPS-EC1500.036	45	33,3	36	41,7	1500/1501W
CPS-EC1500.048	58	25,8	48	31,2	1500/1498W
CPS-EC1500.060	75	20,0	60	25,0	1500/1500W
CPS-EC1500.072	90	16,7	72	20,8	1500/1498W
CPS-EC1500.110	137,5	10,9	110	13,6	1500/1496W
CPS-EC1500.150	180	8,3	150	10,0	1500/1500W
CPS-EC1500.220	264	5,7	220	6,8	1500/1496W
CPS-EC1500.400	400	3,75	330	4,6	1500/1518W

Inrush Current Limiter

The unit is featured with an electronic inrush current limiter (ex. 230Vac = 14,7Arms / 20,7Apeak). The built-in circuit is a very precise limiter and no simple NTC thermistor solution. The circuit works with an accuracy of $\pm 10\%$. The accuracy is independent from the ambient temperature and from the number of power-on sequences. The quickest recommended MCB is B-type 16A (230Vac). The smallest power relay or a contactor in front of the CPS-EC1500 must cope 20,7A peak current. The inrush duration is 400ms and the overall power up time of the unit is 500ms. See the below drawings for technical information.

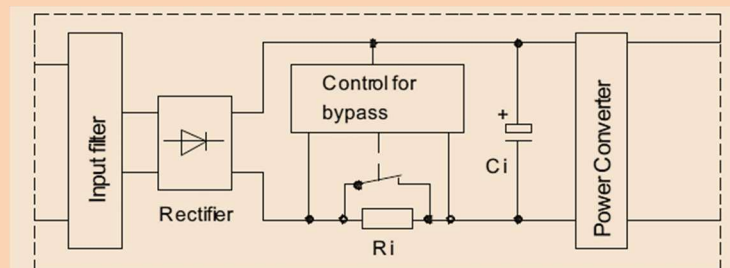
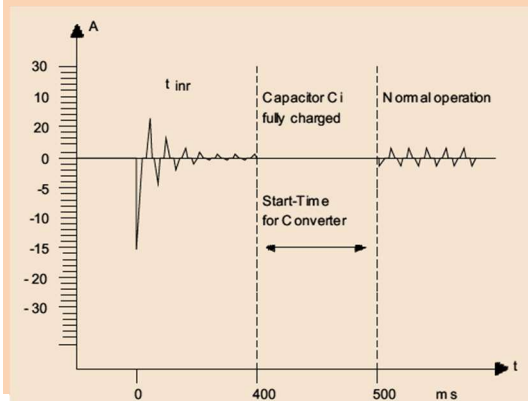

Overtemperature Thermal Shutdown, Over Voltage Protection & Derating

OT Over Temperature The maximum ambient temperature is +70°C. If the power Supply exceeds this value (over temperature protection) it completely shuts down (metering point 50mm from outside device). The device restarts automatically into operation when the temperature drops to a normal value.

OVP Over Voltage Protection Exceeding the OVP results into ticker mode. Resuming the failure causes automatic restart into normal operation. For the values please read the Technical Table on page 2.

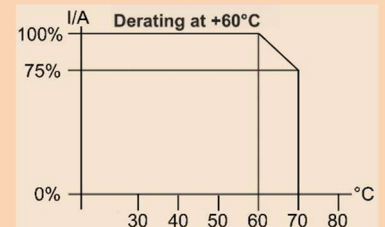

Baseplate Cooling & Temperature Management

The temperature management of the CPS-EC series provides a direct dissipation of the main energy losses. The internal coolers of the output diodes and the power FETs connect to the back-plate cooler. It is possible to dissipate about 40 – 50% of the energy losses out of a system while using the Baseplate cooling bundle 2201002001 to hard mount the unit to a plane and heat conductive surface.

Series Operation

Two or more units of the same model and output voltage can be operated up to a total voltage of 600Vdc in series (not applicable with EN62368-1). The CPS-EC1500 models are to be operated with floating output when connected in series. Such the output terminals must not be connected to earth (GND/PE). Due to the dielectric strength of the internal components used, only the models with an output voltage of 90Vdc and later are approved for series operation. Other power supplies are not approved for series operation above 60Vdc. If the units are remotely controlled via the analog interface it is compulsory to use a potential-free control voltage!

Parallel Operation & Decoupling

To increase the overall power of the power supply, two or more devices of the same model with the same output voltage may be operated in parallel. We recommend using a busbar for the DC power connector. Make sure that the cable lengths and cable cross-sections of all power supplies to the busbar or to the star point are identical. If you want to use the sensing function, connect it also to the star point or busbar. To avoid measurement errors, select the line length from the neutral point or from the busbar to the load as short as possible and use the maximum possible conductor cross-section

The CPS-EC models have no internal O-ring diode, to operate the devices redundant N+1.

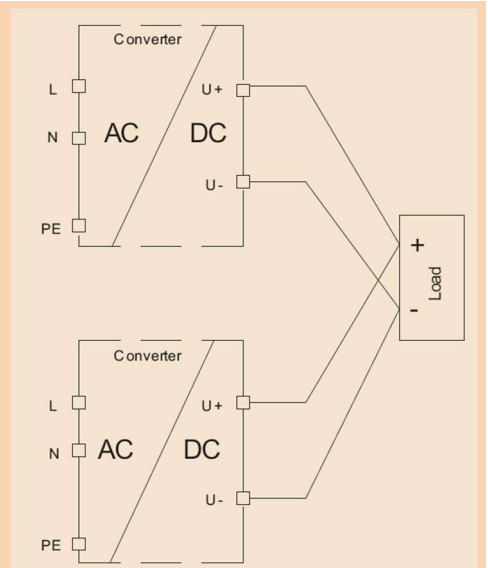

Coating Option

CPS-EC1500(R2) MANUAL

We offer the CPS-EC series with an optional coating. It is to be used in e.g. dusty, dirty, high humidity area or in awaiting quick temperature changes. Short circuit and corrosion at print board lines and at solder points can be prevented. The coat itself is a transparent acrylic resin.

Peters SL 1306 N-FLZ (transparent) IEC60216-1 2001, IPC-CC-830B, UL listed as permanent coating
File No.: E80315 , UL94V-0

Ordering Information: add extension **C** to the model name (example): CPS-EC1500.048**C**(R2)

Electrical Safety (Factory-Test / Field-Test Owner)

	T	A	B	C ¹⁾	D	E
Type Test	60s	2500Vac	3000Vac	500Vdc	3000Vac	500Vdc
Factory Test	5s	2000Vac	2000Vac	500Vdc	900Vdc	500Vdc
Field Test	2s	2000Vac	2000Vac	500Vdc	900Vdc	500Vdc
Cut-off current setting	>25mA	>25mA	>1mA	>1mA	>1mA	>1mA

¹⁾ ≥48Vdc= 2800Vdc

Type and factory test are the manufacturer. While repeating damage can happen to the power supply unit. For the field test (owner) follow the below instruction:

- Use suitable test equipment, raising the voltage slowly
- Short circuit L1 and N, and all the DC output terminals.
- Use only test voltages of 50/60Hz. The outputs are unearthed and therefore they have no resistance to GND/PE.
- If the residual voltage is ≥60Vdc, observe the safety standards. Use only specially insulated screwdriver to trim the Ua/Ia.

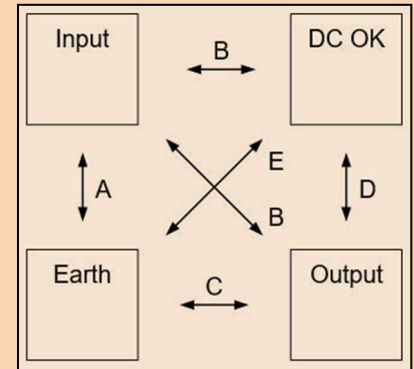

Connections

AC Main Input	DC Mains	Inputs/Outputs	Sense
PE - wire	DC + voltage	Imon = current monitor output	B= sense connections (S+/-)
N - wire	DC + voltage	SD = shut down input	
L - wire	DC - voltage	INH = inhibit connection	
	DC - voltage	DC-ok = power good relay	
		BC = boost charge	

CPS-EC1500(R2) MANUAL

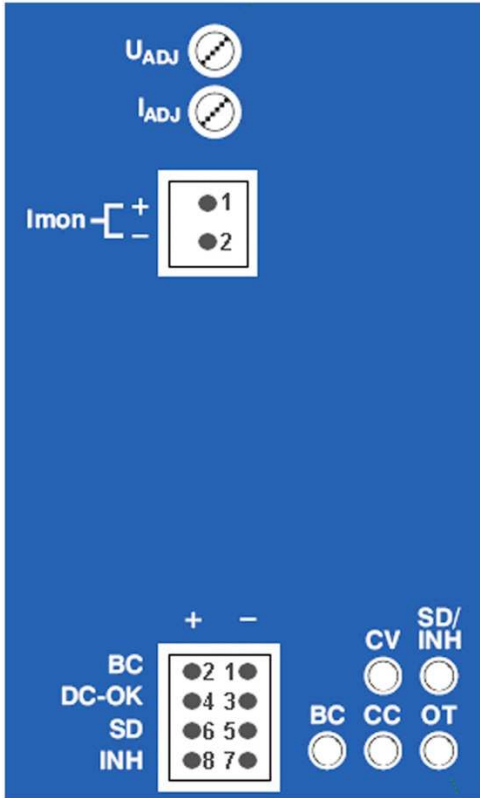

LED :
 CV Constant V
 CC Constant C
 BC Boost Charge
 OT Over Temperature Protection
 SD/INH Shut Down / Inhibit (Interlock)

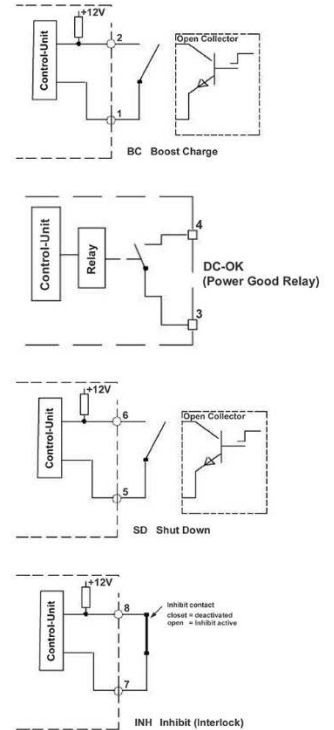

Mechanics

Mechanics

Stable metal/aluminum housing IP20. To allow adequate convection, a free air space of 50mm (top/bottom) and 5mm (sidewalls) is required; for active devices 15mm space from the sidewalls. For free air convection it is necessary to install the unit horizontal. Use the DIN-Rail installation (equipped standard) with the patented 35mm DIN-Rail brackets according to EN60275. It is easy to mount/dismount while snapping it onto the 35mm DIN-Rail - no tools are necessary. A hard mount backplate (option) is available as well.

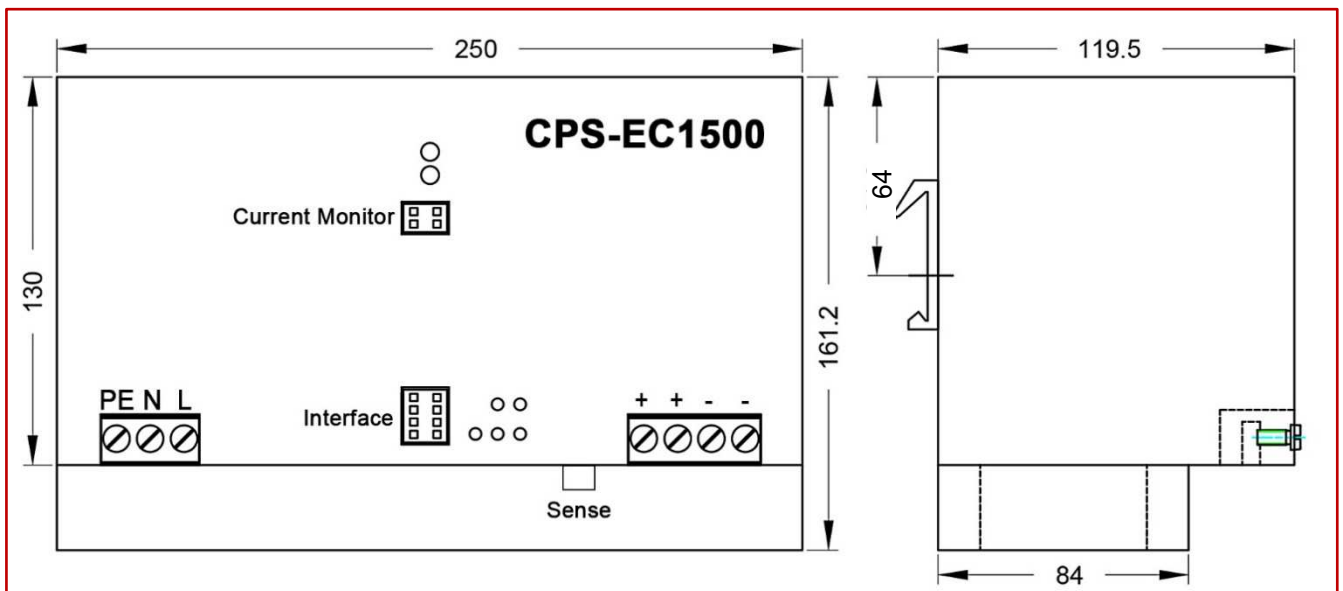

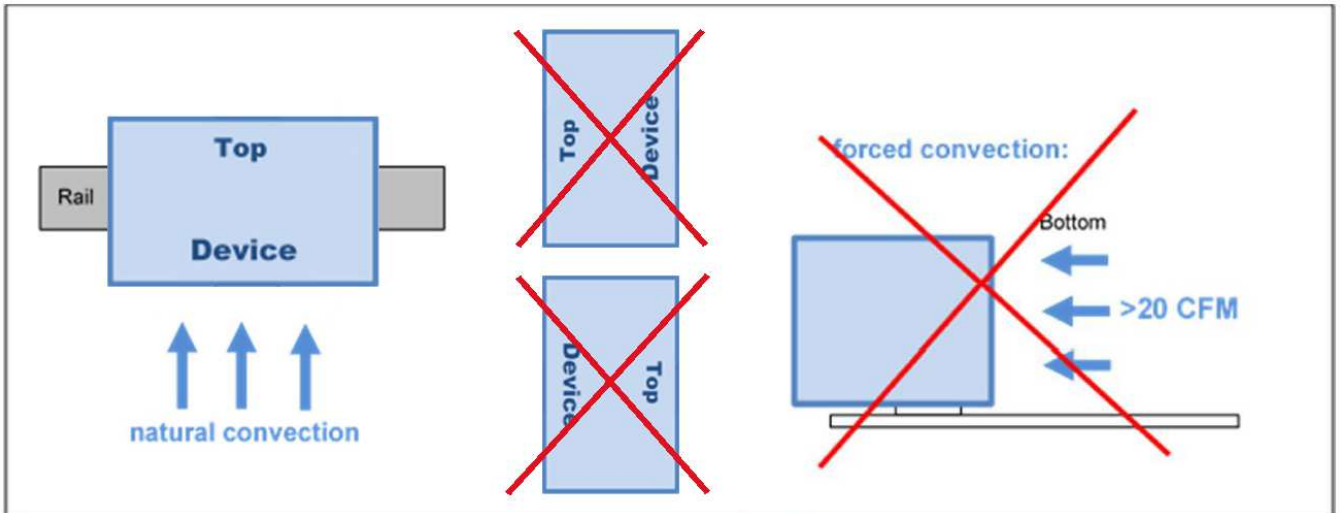

Mounting Instruction: recommended air flow space below and above is 50mm (2 Inch)

Mechanics & Installation Instruction of the CPS-EC1500

Stable metal/aluminum housing IP20. To allow adequate convection, a free air space of 50mm (top/bottom) and 10mm (sidewalls) is required; and for active devices 15mm space from the sidewalls. For proper air convection it is necessary to install the CPS-EC1500. One can use the DIN-Rail installation (equipped standard) with our patented 35mm DIN-Rail bracket according to EN60275. It is easy to mount/dismount while snapping it onto the 35mm DIN-Rail - no tools necessary. A wall mount back plate (option) is available, too.

It is not allowed to install the CPS-EC1500 in other mounting direction then as shown in the drawings.

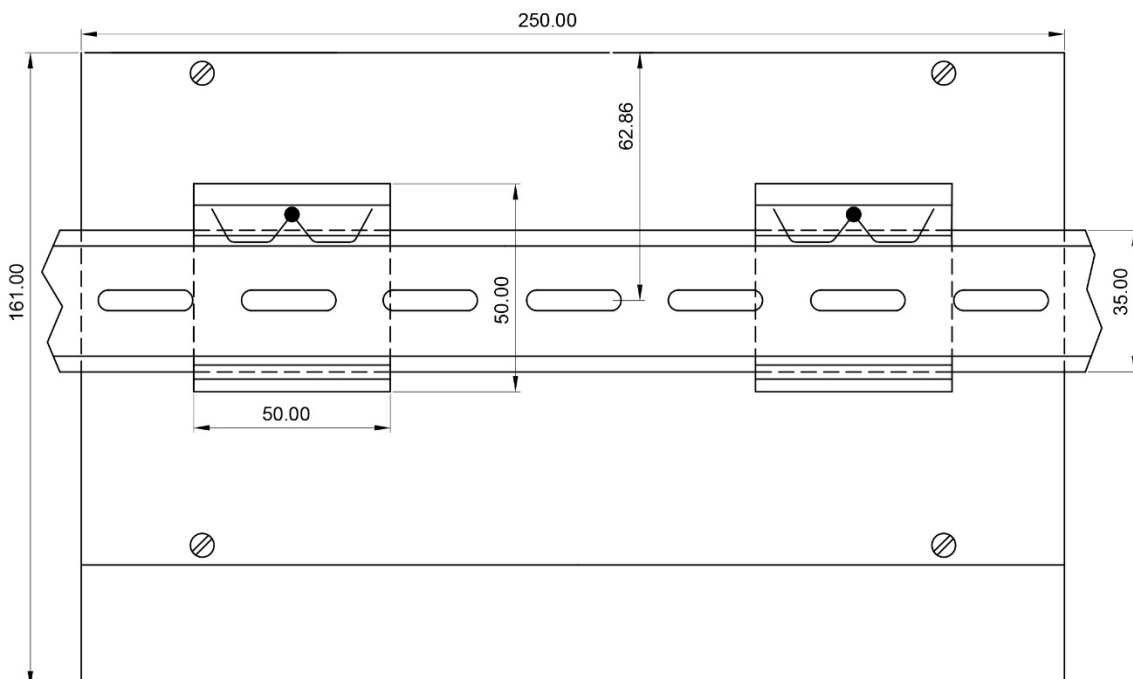

Back Plate Option / DIN-Rail Standard

(The CPS-EC1500 is always delivered for DIN-rail mount, the back-plate is an optional part that shall be mounted from the customer. The threads from the DIN-rail mounting brackets shall be used. All screws are included into the Back-Plate Kit.)

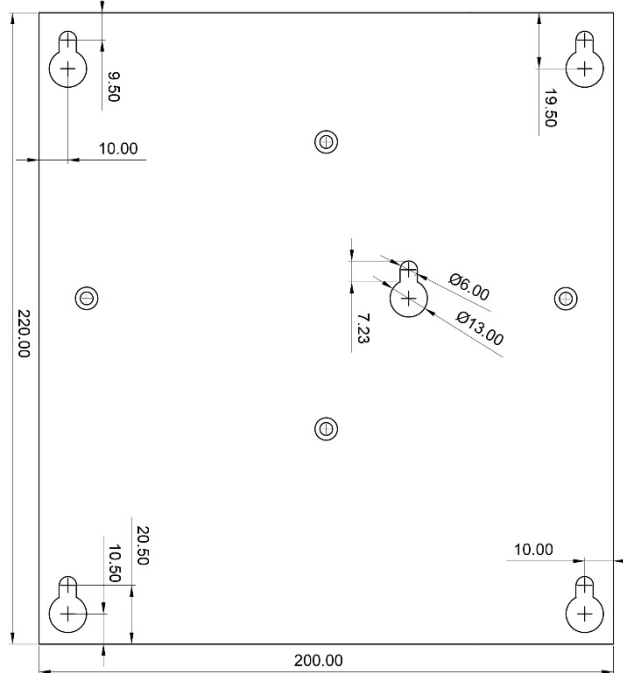

Connections

Clamping Yoke Connector Specifications

	Input / Output connections	Signal connections plugs
Tightening torque min. – max.	1,2 – 2,2Nm (blade 1,0x5,5 DIN5264)	0,2 – 0,25Nm (blade 0,4x2,2 DIN5264)
Touch-safe protection acc. to DIN VDE 0470	IP20 plugged/ IP10 unplugged	Not applicable
Clamping range, min. – max.	0,5 – 16mm ² / AWG26 – AWG6	0,2 – 1,5mm ² / AWG28 – AWG14
Solid, H05(07) V-U min. – max.	0,5 – 16mm ²	0,2 – 1,5mm ²
Stranded, H05(07) V-U min. – max.	6 – 16mm ²	0,2 – 1,5mm ²
Flexible, H05(07) V-U min. – max.	0,5 – 16mm ²	0,2 – 1,5mm ²
w. plastic collar ferrule, DIN 46228 pt 4 min. – max.	2,5 – 10mm ²	0,2 – 1,5mm ²
w. wire end ferrule, DIN 46228 pt 1, min. – max.	2,5 – 10mm ²	0,2 – 1,5mm ²
Plug gauge in accordance with EN 60999 a x b; ø	5,4 x 5,1mm; 5,3mm	2,4 x 1,5mm; 2,3mm
Pitch (P)	10,16mm	3,5mm

Wire Stripping Length (fine wired)

Nominal Cross Section	Wire End Ferrule	Stripping Length	Wire End Ferrule	Stripping Length
0,25mm ²	H0,25/5	5mm	H0,25/10 HBL	8mm
0,5mm ²	H0,5/6	6mm	H0,5/12 OR	8mm
1,0mm ²	H1,0/6	6mm	H1,0/12 GE	8mm
2,5mm ²	H2,5/12	12mm	H2,5/19D BL	14mm
4,0mm ²	H4,0/12	12mm	H4,0/20 GDR	14mm
6,0mm ²	H6,0/20	12mm	H6,0/20 SW	14mm
10,0mm ²	H10,0/12	12mm	H10,0/22 EB	15mm



The length of ferrules is to be chosen depending on the rated voltage. The outside diameter of the plastic collar should not be larger than the pitch (P)

Ordering Information

Ordering Codes

Product Code	Information	Article Number
CPS-EC1500.024(R2)	24V	3041400001CA
CPS-EC1500.036(R2)	36V	3041400002CA
CPS-EC1500.048(R2)	48V	3041400003CA
CPS-EC1500.060(R2)	60V	3041400004CA
CPS-EC1500.072(R2)	72V	3041400005CA
CPS-EC1500.110(R2)	110V	3041400006CA
CPS-EC1500.150(R2)	150V	3041400007CA
CPS-EC1500.220(R2)	220V	3041400008CA
CPS-EC1500.400(R2)	400V	3041400009CA
Back Plate Kit	Base Plate / Hart mount plate kit including screws	2201002001CA

Safety regulations: Please read these instructions completely before using the equipment. Keep these instructions on to hand. The device may only be operated by trained specialist staff.

Installation:

- 1) The device is designed for devices and systems that meet the standard requirements for hazardous voltages, power, and fire prevention.
- 2.) Installation and service only by trained persons. The AC power must be switched off. The work is to be labelled; accidental reconnection of the system must be prevented.
- 3.) Opening the device, its modification, loosening bolts, or operation outside the specified herein specification or in an unsuitable environment, has the immediate loss of warranty to follow. We disclaim any responsibility for any resulting damage to persons or things.
- 4.) Note: The device must not be operated without an upstream circuit breaker (CB). We recommend the use of B-Type 16A. It is prohibited to use the unit without PE. It may be necessary upstream device has a power switch.

Warning:

Non-compliance these warnings can result in fire and serious injury or death.

1. Never operate device without PE connection.
2. Before connecting the device to the AC network, make wires free of voltage and assure accidentally switch on.
3. Allow neat and professional cabling.
4. Never open nor try to repair the unit. Inside are dangerous voltages that can cause electrical shock hazard.
5. Avoid metal pieces or other conductive material to fall into the item
6. Do not operate the device in damp or wet conditions
7. Do not operate the unit under EX-conditions

