

CPS-EC1000 1008W Precision DC Rectifier

DIN-Rail Battery Charger, C/V Adjustable Industrial Power

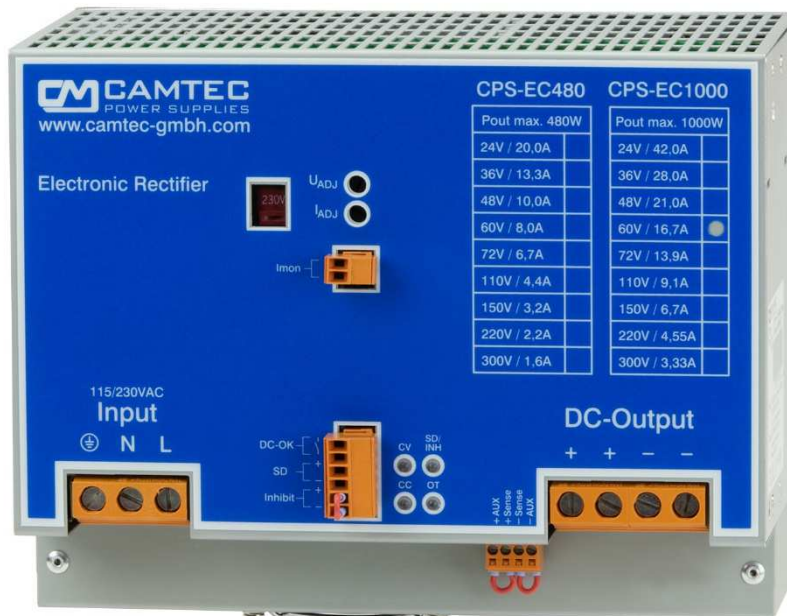

Specification:

- Real time output current monitoring
- Precision potentiometer f. voltage & current
- Power Good Relay AC & DC-ok
- C/V curve down to 0V, no foldback
- Sense control 1V per load line
- Electronic inrush current limiter 13.8Apeak
- Inhibit function (Interlock)
- External shutdown
- Efficiency up to 92%
- Precise dynamic response to load change
- Designed for long life under full stress
- Strong input filters
- Hold up time >30ms
- Soft start & auto-recovery
- High reliability, shock & vibration proof
- EMC meets CE norm class B
- Overload and short circuit protection
- Large terminals 4x AWG22 – AWG6 (0,5 – 16mm²)

Models	Voltage	Voltage setting	Current setting
CPS-EC1000.024	24Vdc	24 – 30Vdc	21 – 44,1A
CPS-EC1000.036	36Vdc	36 – 45Vdc	14 – 29,4A
CPS-EC1000.048	48Vdc	48 – 58Vdc	10,5 – 22A
CPS-EC1000.060	60Vdc	60 – 75Vdc	8,4 – 17,6A
CPS-EC1000.072	72Vdc	72 – 90Vdc	7,0 – 14,6A
CPS-EC1000.110	110Vdc	110 – 137,5Vdc	4,6 – 9,6A
CPS-EC1000.150	150Vdc	132 – 180Vdc	3,4 – 7A
CPS-EC1000.220	220Vdc	220 – 264Vdc	2,3 – 4,8A
CPS-EC1000.300	300Vdc	264 – 360Vdc	1,7 – 3,5A



Technical Concept

The Camtec CPS-EC series is a high precision switch mode power supply for an upscale demand. The unit is C/V adjustable. It is engineered and manufactured by CAMTEC in Germany. The designed meets challenging applications like railway, complex drives, battery charging for DC-UPS, test-stands, machine-building and professional LED lighting. The power supply provides a low ripple-noise, a precise load-regulation and high efficiency up to 94%. High-end long-life capacitors guarantee an extended hold-up-time and an extraordinary lifetime of the power supply. The circuit design starts complex loads easily. The internal control circuit manages illegal operating conditions to prevent your system from damages. The CPS-EC series features active high input transients with suppressor diodes, X2-capacitors and varistors. All inputs, outputs and feature connections are galvanic isolated. The design rules set value on extended interference immunity and safety. The unit is designed in accordance with the EN60950-1, EN62368-1, EN61010-1, EN61010-2-201 and the EMC-compatibility with EN55032.

Features

Design Conception

The CPS-EC power supply series realizes very high-power efficiency in a space-saving housing. Latest generation electrical devices relate to the high reliability of all CAMTEC products. The CAMTEC philosophy is, to employ 125°C low ESR ultra long-life capacitors where expedient to achieve a superior lifetime of the product. The CPS-EC power supply is made for high reliable and demanding industrial applications, railway, unbreakable power supply charger (DC-UPS), professional high-power lighting (floodlight, production hall) and for telecom & demanding IT applications.

Voltage Setting Potentiometer

The output voltage limit can be adjusted with a 15 turns high precision potentiometer. The listed values are guaranteed by the factory. The tolerance of the upper margin is -0/+5%. The tolerance of the lower margin is -5%/+0%. The output voltages cover the typical cell voltage range of standard lead acid batteries.

Current Setting Potentiometer

The output current limit can be adjusted with a 15 turns high precision potentiometer. The listed values are guaranteed by the factory. The tolerance of the upper margin is -0/+5%. The tolerance of the lower margin is -5%/+0%.

Output Current Monitoring

The CPS-EC power supply features a 0-5Vdc signal output. It is a real-time linear signal and indicates the current consumption of the load. The measuring point is directly at the output connection of the device.

Sensing

The device has a sense operation mode to compensate a voltage drop at the load line.

Inhibit contact (Interlock)

The inhibit inputs can be connected to a safety contact or a safety relay. When the contact is open the power supply will remain in a completely locked shut down mode. The unit powers up as soon as the contact is closed.

External Shutdown feature

All CPS-EC units are featured with a shutdown (open collector).

DC-ok Power Good Relay

The PG Relay connection indicates over temperature, low DC-voltage at the output, low AC supply voltage at the input, the inhibit and the shutdown mode.

Galvanic Isolation

The power supply is galvanic isolated between the input and the output. All features like Shut Down, Inhibit, Power Good Relay, Sensing and the Current Monitoring are connected to the DC power outputs.

Thermal shutdown

The CPS-EC series is featured with a thermal overload shut down and auto recovery behaviour.

Over Voltage Protection

Ticker mode and auto recovery

Short Circuit Protection

A continuous short circuit does not cause damage to the power supply. The CPS-EC delivers constant current and 0 output voltage. It recovers automatically after the short circuit is released.

Open Circuit Protection

The CPS-EC series is continuously open circuit protected. The device delivers a stable output voltage and no current. If a load is immediately connected to the device, the power supply stabilizes within 1ms. It does not overshoot the output voltage.

Power Up Ramp

The devices have a soft start ramp when powering up. The device does not either overshoot the voltage nor does the output flutter – independent if a load is connected or not.

Inrush Limiter

The power supply provides an electronic inrush current limiter that works absolute accurately with a low inrush of only 9,8A RMS value. The limiter works independent from the ambient temperature and its tolerance is only $\pm 10\%$.

Current Voltage Chart, CV & CC mode

The CPS-EC series provides a perfect current voltage chart. It has no fold back or other abnormalities. The output voltage can drop down to zero volts when the power supply is overloaded. The unit delivers a stable and constant current to the outputs. The device can be used either in the CV or in the CC mode (auto switch).

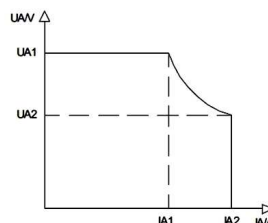



Technical Data Table									
AC Input Range	90 – 132Vac / 184 – 264Vac , 47 – 63Hz (115/230Vac input selector, factory setting is 230Vac)								
DC Input Range	250Vdc – 375Vdc (input selector set to 230Vac)								
AC Input Rated	115Vac<17,2A 230Vac<9,8A								
DC Input Rated	250Vdc<5,0A 375Vdc<3,3A (input selector set to 230Vac rated)								
Rated DC Voltage	24Vdc	36Vdc	48Vdc	60Vdc	72Vdc	110Vdc	150Vdc	220Vdc	300Vdc
Rated DC Current	42A	28A	21A	16,7A	13,9A	9,1A	6,7A	4,55A	3,33A
DC Voltage Setting Range	24 – 30Vdc	36 – 45Vdc	48 – 58Vdc	60 – 75Vdc	72 – 90Vdc	110 – 137,5Vdc	132 – 180Vdc	220 – 264Vdc	264 – 360Vdc
DC Current Setting Range	21 – 44,1A	14 – 29,4A	10,5 – 22A	8,0 – 17,6A	7,0 – 14,6A	4,6 – 9,6A	3,4 – 7,0A	2,3 – 4,8A	1,7 – 3,5A
Over Voltage Protection	34Vdc	50Vdc	67Vdc	84Vdc	100Vdc	154Vdc	210Vdc	310Vdc	420Vdc
Over Current Protection	44,1A	29,4A	22A	17,6A	14,6A	9,6A	7,0A	4,8A	3,5A
Ripple Noise 230Vac 20MHz	40mV	40mV	100mV	150mV	200mV	300mV	400mV	400mV	400mV
Power Rated	1008W, 90-132Vac, 184-264Vac								
Potentiometer C/V Setting	15 turns high precision, protective forced isolation to the inputs and the output 3000Vac								
Operation Failure Relay	Yes, break contact, protective forced isolation to the inputs and the output 3000Vac								
Sense Function	Compensation 1V per load line								
Remote Shutdown	Yes, protective forced isolation to the inputs and the output 3000Vac								
Inhibit Function (Interlock)	Yes, protective forced isolation to the inputs and the output 3000Vac								
Derating	+60°C...+70°C 2.5%/°C								
Accuracy	< ± 1.5% interface								
Load Regulation	< ± 0.05% 0-100%								
Start up from Shutdown	Typ. 320ms								
Start up from Inhibit	Typ. 320ms								
Response to Load Change	<1ms 10-100%, 100-10%								
Base Load	None required (open circuit proof)								
Efficiency 230Vac	Up to 92% at 90% load								
Short Circuit Protection	Continuous								
Open Circuit Proof	Continuous								
Temperature Control	Yes, thermal shutdown with auto recovery (+70°C, metering distance 10mm)								
Hold Up Time	>30ms 230Vac								
Inrush Current	<9,8Aeff < 13.8Apeak (230Vac) active inrush current limiter								
Soft Start	100ms typical								
Cooling	Controlled Fan from manufacturer EBM Papst (Germany)								
Ambient Operating Temp.	- 25°C...+70°C								
Ambient Storage Temp.	- 40°C...+85°C								
Environment	Humidity 95% non-condensing @ 25°C, climate class. 3k3, pollution rate II								
ROHS	2011/65/EU, (EU)2015/863								
REACH	EG No. 1907/2006								
EMI	EN55032 conducted class B, radiated class A, EN61000-6-3								
EMS	EN61000-6-2								
Safety	EN61010-1, EN61010-2-201, EN62368-1 (not 300Vdc model), EN60950-1, EN60204-1								
Protection Class 1	PE connection required								
Isolation Paths	> 8mm creepage distance & clearance paths								
Input to Output Isolation	3000Vac								
Input to Case Isolation	2500Vac								
Output to Case Isolation	500Vdc , models ≥48Vdc 2500Vdc								
Meantime By Failure (MTBF)	389000h (IEC61709)								
Meantime To Failure (MTTF)	143034h (IEC61709)								
Dimensions (HxWxD)	156x200x114.5mm								
Weight	3400g								
AC Terminals	Input Screw Terminal 3x AWG22 – AWG6 / 0,5 – 16mm ² (L,N,PE)								
DC Terminals	Output Screw Terminal 4x AWG22 – AWG6 / 0,5 – 16mm ² (+ + / - -)								

Manual and Technical Details

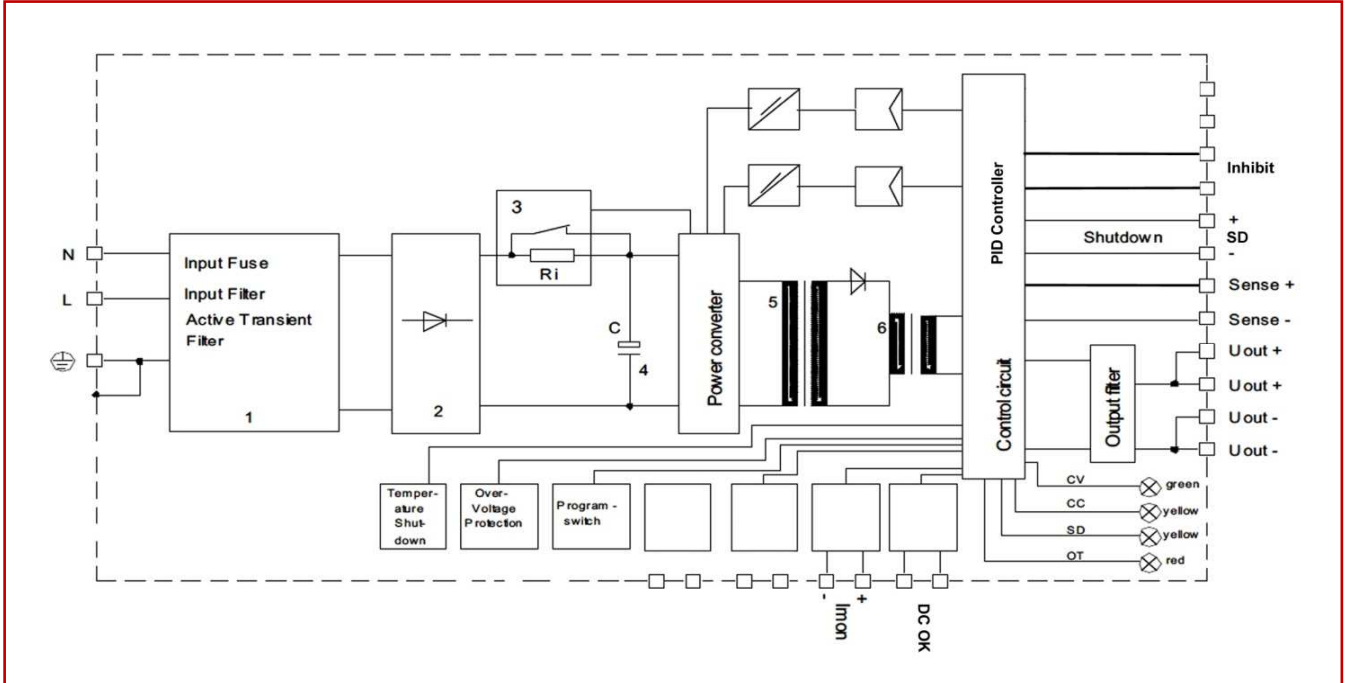

1) Active Transient Filter 2) Rectifier 3) Inrush Current Limiter 4) Load Capacitor 5) Power Transformer 6) Storage Choke
 LED: CV = constant voltage operation CC = constant current operation SD/INH = shutdown / inhibit OT = temperature failure >70°C

Technical Data Table - Analogue Interface & Voltage Current Control

Feature	Technology	Details and Connections	Section	Isolation
Potentiometer Voltage	15 turns	High precision	U adj	3000Vac to input & output
Potentiometer Current	15 turns	High precision	I adj	3000Vac to input & output
Monitoring Current	0...5Vdc/5mA	AWG22 – AWG6 / 0,25 – 2,5mm ²	I mon	3000Vac to input
Shutdown	Open Collector	AWG22 – AWG6 / 0,25 – 2,5mm ²	SD	3000Vac to input & output
Inhibit (Interlock)	Passive	AWG22 – AWG6 / 0,25 – 2,5mm ²	Inhibit	3000Vac to input & output
Sense Compensation	1V per load line	AWG22 – AWG6 / 0,25 – 2,5mm ²	Sense & Aux	3000Vac to input
Power Good Relay	“b” contact	AWG22 – AWG6 / 0,25 – 2,5mm ²	DC-OK	3000Vac to input & output

All potentiometers and all the inputs and the outputs of the analogue interface provide a forced isolation. It is to ensure a protective isolation for the 300Vdc.

DC Voltage & Current adjustment range

	24Vdc	36Vdc	48Vdc	60Vdc	72Vdc	110Vdc	150Vdc	220Vdc	300Vdc
Rated DC Voltage	24Vdc	36Vdc	48Vdc	60Vdc	72Vdc	110Vdc	150Vdc	220Vdc	300Vdc
Rated DC Current	42A	28A	21A	16,7A	13,9A	9,1A	6,7A	4,55A	3,33A
DC Voltage Setting Range	24 – 30Vdc	36 – 45Vdc	48 – 58Vdc	60 – 75Vdc	72 – 90Vdc	110 – 137,5Vdc	132 – 180Vdc	220 – 264Vdc	264 – 360Vdc
DC Current Setting Range	21 – 44,1A	14 – 29,4A	10,5 – 22A	8,0 – 17,6A	7,0 – 14,6A	4,6 – 9,6A	3,4 – 7,0A	2,3 – 4,8A	1,7 – 3,5A

The DC voltage and the current can be adjusted with a high precision 15 turn potentiometer with low temperature fading. The factory setting is to the rated voltage & current from the table above. Due to the tolerances of the potentiometers, the lower margin of the output voltage can be adjusted below the upper threshold margin of the DC Power Good Relay (see p.6). To ensure a proper operation, the DC voltage setting must stay above the upper hysteresis level of the Power Good Relay. We guarantee the above given adjustment ranges with a tolerance of -5/0% for the lower margin and 0/+5% for the upper margin.

Monitoring of the Output Current Consumption

The Current Monitor I_{mon} output is buffered with OP-amplifiers, pre-resistors & parallel connected Zener diodes. The monitor output delivers 0-5Vdc 5mA control voltage. The signal is absolute proportional to the adjusted output current. The signal is real time, and the measuring point is exactly at the DC outputs of the power supply unit. The monitoring is directly connected with the DC power outputs.

Sensing (Load Line Compensation)

The CPS-EC provides a sensing function to compensate a voltage drop from the load lines. The maximum compensation is 1V. Be aware that this operation mode may recommend extended preparations concerning interference elimination. If the sensing feature is not in use the S +/- must be connected to AUX +/- with very short wires (Factory setting).

To use the sensing feature, please disconnect the local sensing wires from the AUX +/- and the S +/- connections. Connect the sense lines to the load. Be sure that +/- connections are matching!

WARNING! Reverse polarity of the sense lines can cause damages to the power supply unit.

To basically prevent from interferences, enable to twist sense compensation lines. To reduce inductive influences, make sure that the load wires are installed close to each other. Driving a pulsative load requires a large electrolytic and a ceramic capacitor. Make sure that C1 & C2 are not oscillating with load wires. It would cause ripple voltage into the load lines. The internal over voltage protection (OVP) controls the output voltage directly at the DC output connections. It opens automatically in case of a failure from the DC source (see OVP table).

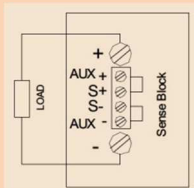

Local Sensing
(factory setting)

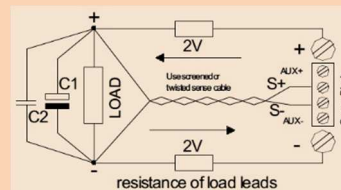

Remote Sensing
(twist wires)

Remote Sensing with Battery Charger

When using the CPS-EC as a battery charger please avoid the remote sensing operation mode. It may cause serious damage to the unit when the battery connections are being mixed up. If you really need to install a remote sensing apply to the below figure circuit. Good values are 250mA for the Si fuses and 3...5A capability for the diodes.

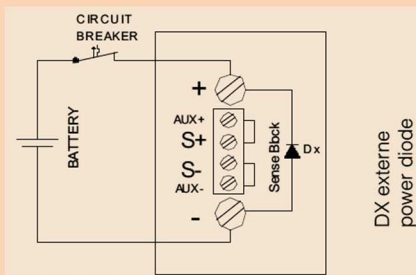

DX externe
power diode

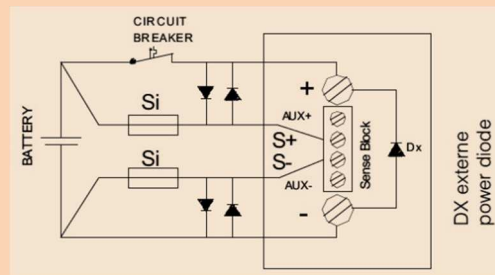

DX externe
power diode

Inhibit (Interlock)

The inhibit inputs can be connected to a safety contact or a safety relay. When the contact is open the power supply will remain completely locked in a shutdown mode. The unit powers up immediately when the connection is closed. The current through the inhibit connection is typically 2mA.

WARNING! It is prohibited to apply an external voltage to the inhibit connection! The CPS-EC unit can be damaged seriously! Always use passive mechanical contacts from switchers or relays.

Shutdown

All CPS-EC units are featured with an external shutdown (open collector). The power supply operates when the connection is open. When the connection is closed the power supply goes into a standby mode (short circuited). The power supply powers up as soon as the shutdown connections is opened. The signal through the connections is 1Vdc max. . The shutdown connections have an internal pull-up resistor with 4700 Ω at the plus line (max. +12V inserted).

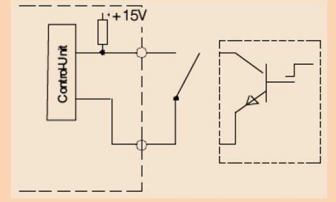

DC-OK (Power Good Relay)

The DC ok relay indicates if the output voltage is low and if the AC voltage is low. The contact is galvanic insulated to the AC input and the DC output connections. The isolation is 3000Vac with a forced isolation and covers the overall adjustment range of the CPS-EC series up to 400Vdc. If the DC voltage is ok the relay is closed, if the power supply unit is in false operation, in the shutdown or in the inhibit mode, the relay is open. Considering the lower and the upper margin of the AC voltage detection it is to say that the CPS-EC series starts at 80Vac/150Vac depending on the AC input selector. The unit starts with 210Vdc when a DC voltage applies to the input. Make sure to set the AC input selector to 230Vac (factory setting) for DC input supply.

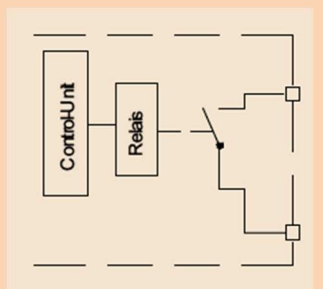

The below table of values shows the hysteresis of the lower and upper threshold margins where the DC OK Relay indicates a low voltage. The nominal voltage of the cell voltage of a typical lead acid battery VRLA & vented GEL & AGM is listed (OPsZ, OPzS, OPzV, OGi, OGiV, GiV types).

WARNING! Regarding the DC-output voltage setting range it is important to consider that this data sheet shows the guaranteed values. In practise the range will be wider and with some models the lower margin of the setting range will be below the DC ok high margin of the DC-ok relay. Make sure that the output voltage setting will properly stay above the DC ok high margin to avoid false messages from the relay.

Hysteresis & Threshold Margins

Model	Nominal [V]	DC ok low	DC ok high	No. of Cells	Nominal Cell [V]	Input ok low	Input ok high
CPS-EC480.024	24V	21,5Vdc	22,8Vdc	12	26,76 – 28,80Vdc	75Vac 140Vac 175Vdc	80Vac 150Vac 210Vdc (the power supply unit starts at 80Vac/150Vac/210Vdc)
CPS-EC480.036	36V	32,4Vdc	34,2Vdc	18	40,14 – 43,20Vdc		
CPS-EC480.048	48V	43,2Vdc	45,6Vdc	24	53,52 – 57,60Vdc		
CPS-EC480.060	60V	54,0Vdc	57,0Vdc	30	66,90 – 72,00Vdc		
CPS-EC480.072	72V	64,8Vdc	68,4Vdc	36	80,28 – 86,40Vdc		
CPS-EC480.110	110V	99,0Vdc	104,5Vdc	54	120,42 – 129,60Vdc		
CPS-EC480.150	150V	118,8Vdc	125,4Vdc	-	-		
CPS-EC480.220	220V	198,0Vdc	209,0Vdc	108	240,84 – 259,20Vdc		
CPS-EC480.300	300V	237,6Vdc	250,8Vdc	150	334,50 – 360,00Vdc		

DC OK Indication

Power Supply Status	Normal	Low [V]	Over Temperature	Shut Down Closed	Inhibit Open
Relay Operation status	Closed	Open	Open	Open	Open

LED Signal Indication

LED	Low [V]	Over [V]	Over Temp.	Inhibit Open	Shut Down	Constant [V]	Constant [C]
CV	OFF	OFF	OFF	OFF	OFF	ON	OFF
CC	OFF	OFF	OFF	OFF	OFF	OFF	ON
OT	OFF	OFF	ON	OFF	OFF	OFF	OFF
SD/INH	OFF	OFF	OFF	ON	ON	OFF	OFF

C/V Current Voltage Behaviour

The CPS-EC series provides a perfect current voltage chart. It has no foldback or other abnormalities. The output voltage can drop down to zero volts when the power supply is overloaded. The unit delivers a stable and constant current to the outputs. The device can be used either in the CV or in the CC mode (automatic switch over). When the output voltage is set to the maximum demanded value and the current limit reaches its desired margin, the output voltage drops linear down to zero and the unit delivers constant current. Similar is when the upper margin of the voltage allows the current to be dropped by the power reduction behaviour of the CPS-EC series. The C/V setting must meet the $P_{max} = 1000W$!

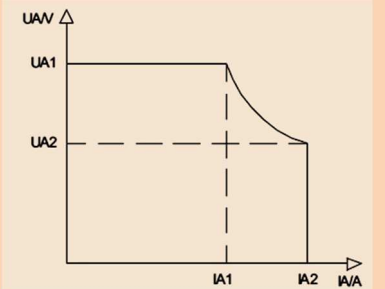

Model	Value UA1 (V)	Value IA1 (A)	Value UA2 (V)	Value IA2 (A)	Pmax
CPS-EC1000.024	30	33,3	24	42,0	1008W
CPS-EC1000.036	45	22,2	36	28,0	1008W
CPS-EC1000.048	58	17,2	48	21,0	1008W
CPS-EC1000.060	75	13,3	60	16,7	1008W
CPS-EC1000.072	90	11,1	72	13,9	1008W
CPS-EC1000.110	137,5	7,3	110	9,1	1008W
CPS-EC1000.150	180	5,6	150	6,7	1008W
CPS-EC1000.220	264	3,8	220	4,5	1008W
CPS-EC1000.300	360	2,8	300	3,33	1008W

Inrush Current Limiter

The unit is featured with an electronic inrush current limiter (ex. $230V_{ac} = 9,8A_{rms} / 13,8A_{peak}$). The built-in circuit is a very precise limiter and no simple NTC thermistor solution. The circuit works with an accuracy of $\pm 10\%$. The accuracy is independent from the ambient temperature and from the number of switch-on sequences. The quickest recommended MCB is B-type 10A (230Vac) / 20A (115Vac). The smallest power relay or a contactor in front of the CPS-EC480 must cope 13,8A peak current (note 18,4A nominal 115Vac). The inrush duration is 400ms and the overall power up time of the unit is 500ms. See the below drawings for technical information.

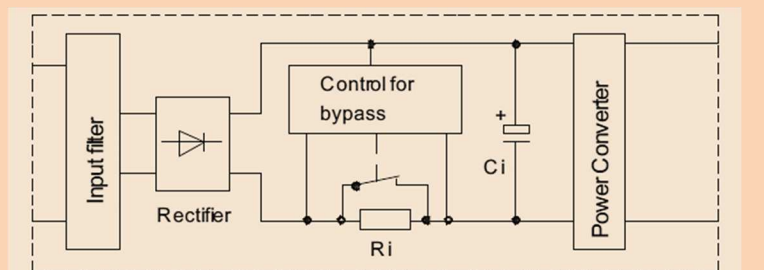
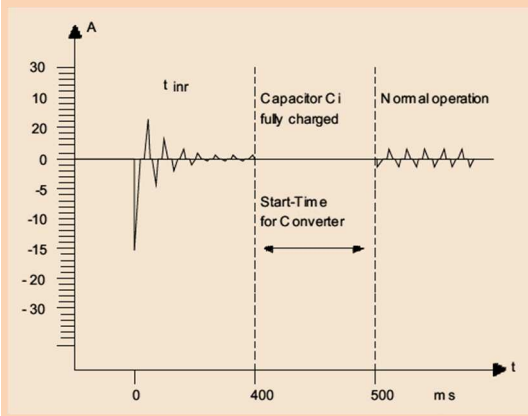

Overtemperature Thermal Shutdown, Over Voltage Protection & Derating

OT Over Temperature The maximum ambient temperature is $+70^{\circ}C$. If the power supply exceeds this value (over temperature protection) it completely shuts down (metering point 10mm from outside device). The device restarts automatically into operation when the temperature drops to a normal value.

OVP Over Voltage Protection Exceeding the OVP results in a locked shutdown mode. Resuming the failure causes automatic restart into normal operation. For the values please read the Technical Table on page 2.

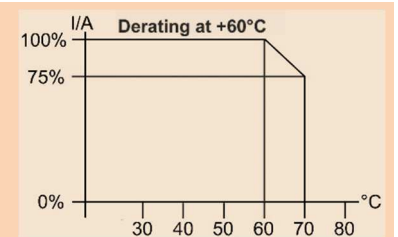

Baseplate Cooling & Temperature Management

The temperature management of the CPS-EC series provides a direct dissipation of the main energy losses. The internal coolers of the output diodes and the power FETs connect to the back-plate cooler. It is possible to dissipate about 40 – 50% of the energy losses out of a system while using the Baseplate cooling bundle 2201002001 to hard mount the unit to a plane and heat conductive surface.

Parallel Operation & Decoupling

To increase the output power up to 5pcs of the CPS-EC units can be parallel connected. Advise using busbars to connect several devices in parallel. Always use identical cabling length and identical cross sections to the busbar or a star point. When sensing is required, we recommend connecting the sense lines to a star point located very close to the load. To avoid erroneous measuring the cable section from the star point to the load shall be as large and as short as possible.

The CPS-EC models have no internal O-ring diode. For decoupling devices N+1. Up to 125Vdc we recommend using our RED00202 DIN rail diode module. It is capable to decouple 2pcs of the CPS-EC power supplies from each other. To increase the power capability RED models can be connected in parallel. For higher voltages, an external decoupling diode shall be installed from the system engineer.

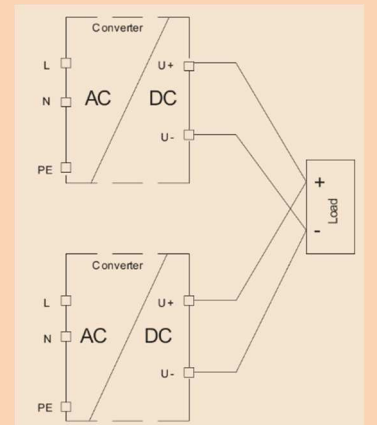

Coating Option

We offer the CPS-EC series with an optional coating. It is to be used in e.g. dusty, dirty, high humidity area or in awaiting quick temperature changes. Short circuit and corrosion at print board lines and at solder points can be prevented. The coat itself is a transparent acrylic resin.

Peters SL 1306 N-FLZ (transparent) IEC60216-1 2001, IPC-CC-830B, UL listed as permanent coating FileNo.: E80315 , UL94V-0

Ordering Information: add extension **C** to the model name (example): CPS-EC1000.048**C**

Electrical Safety (Factory-Test / Field-Test Owner)

	T	A	B	C ¹⁾	D	E
Type Test	60s	2500Vac	3000Vac	500Vdc	3000Vac	500Vdc
Factory Test	5s	2000Vac	2000Vac	500Vdc	900Vdc	500Vdc
Field Test	2s	2000Vac	2000Vac	500Vdc	900Vdc	500Vdc
Cut-off current setting		>20mA	>20mA	>1mA	>1mA	>1mA

¹⁾ ≥48Vdc= 2500Vdc

Type and factory test are the manufacturer. While repeating damage can happen to the power supply unit. For the field test (owner) follow the below instruction:

- Use suitable test equipment, raising the voltage slowly
- Short circuit L1 and N, and all the DC output terminals.
- Use only test voltages of 50/60Hz. The outputs are unearthed and therefore they have no resistance to GND/PE.
- If the residual voltage is ≥60Vdc, observe the safety standards. Use only specially insulated screwdriver to trim the Ua/Ia.

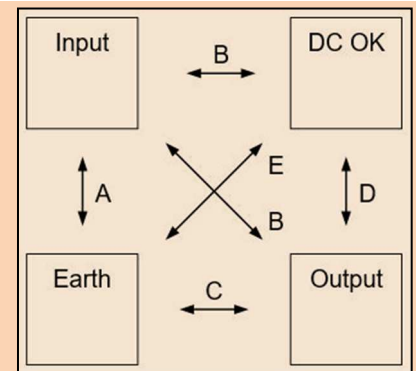

Connections

AC Main Input	DC Mains	Inputs/Outputs	Sense
GND common	DC + voltage	I _{mon} = current monitor output	B= sense connections (S+/-)
N - wire	DC + voltage	SD = shut down input	
L - wire	DC - voltage	INH = Inhibit Connection	
	DC - voltage	DC-ok = power good relay	

Mechanics

Mechanics

Stable metal/aluminium housing IP20. To allow adequate convection, a free air space of 50mm (top/bottom) and 5mm (sidewalls) is required; for active devices 15mm space from the sidewalls. For free air convection it is necessary to install the unit horizontal. Use the DIN-Rail installation (equipped standard) with the patented 35mm DIN-Rail brackets according to EN60275. It is easy to mount/dismount while snapping it onto the 35mm DIN-Rail - no tools are necessary. A hard mount backplate (option) is available as well.

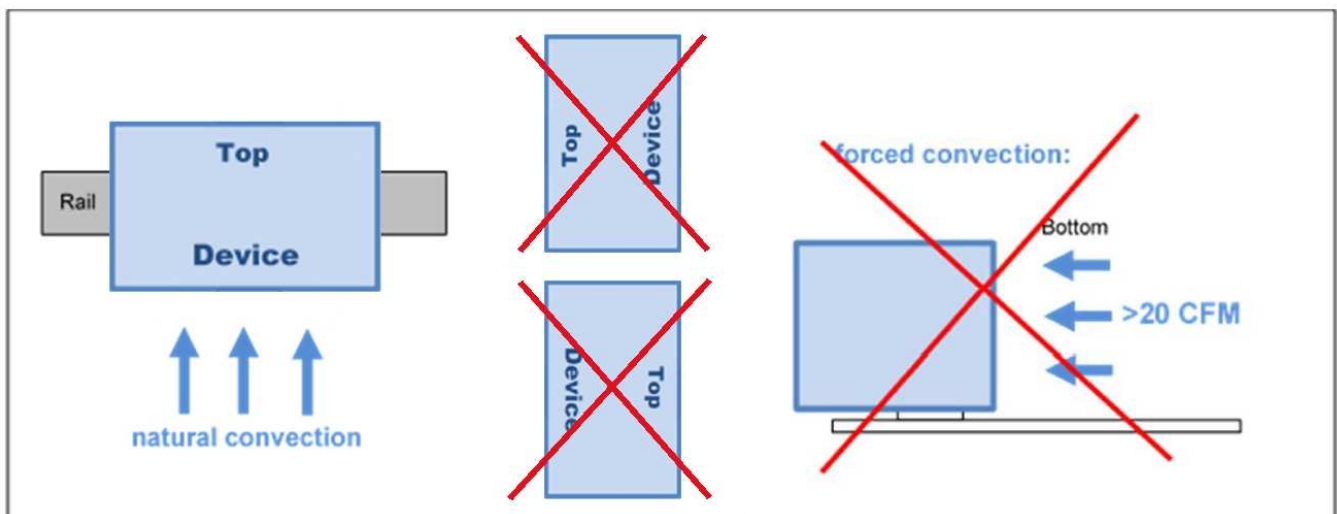
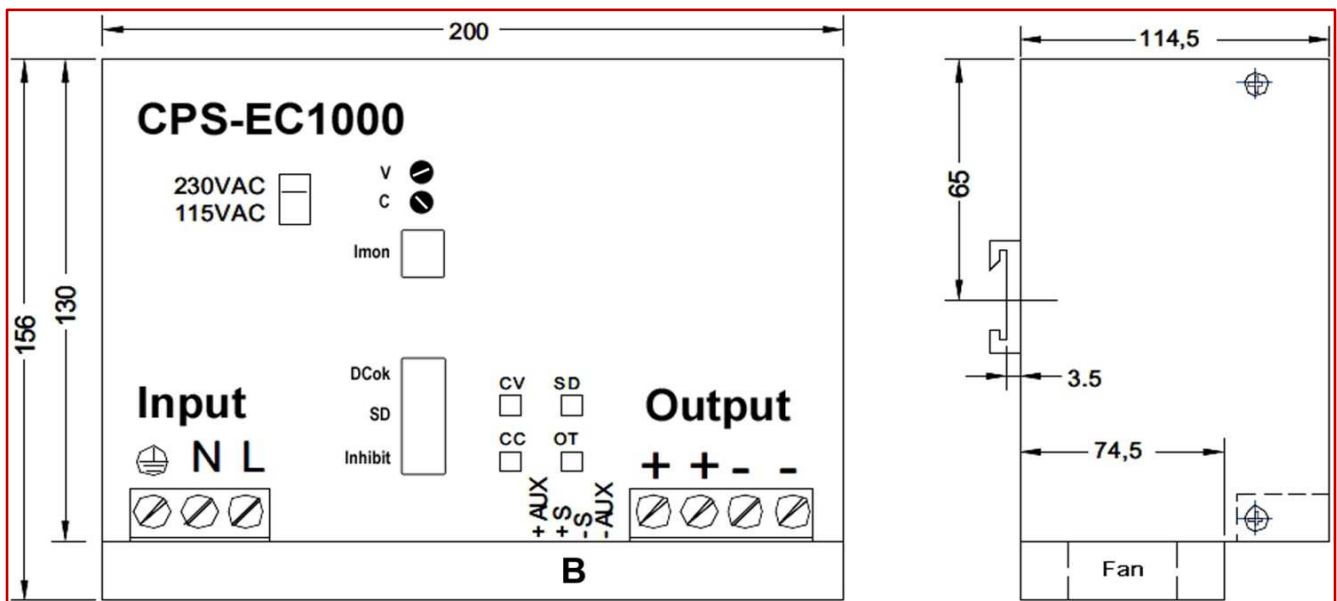

Mounting Instruction: recommended airflow space below and above is 50mm (2 Inch)

Mechanics & Installation Instruction of the CPS-EC1000

Stable metal / aluminium housing IP20. To allow adequate convection, a free air space of 50mm (top/bottom) and 10mm (sidewalls) is required; and for active devices 15mm space from the sidewalls. For proper air convection it is necessary to install the CPS-EC1000. One can use the DIN-Rail installation (equipped standard) with our patented 35mm DIN-Rail bracket according to EN60275. It is easy to mount/dismount while snapping it onto the 35mm DIN-Rail - no tools necessary. A wall mount back plate (option) is available, too.

It is not allowed to install the CPS-EC1000 in other mounting direction then as shown in the drawings.

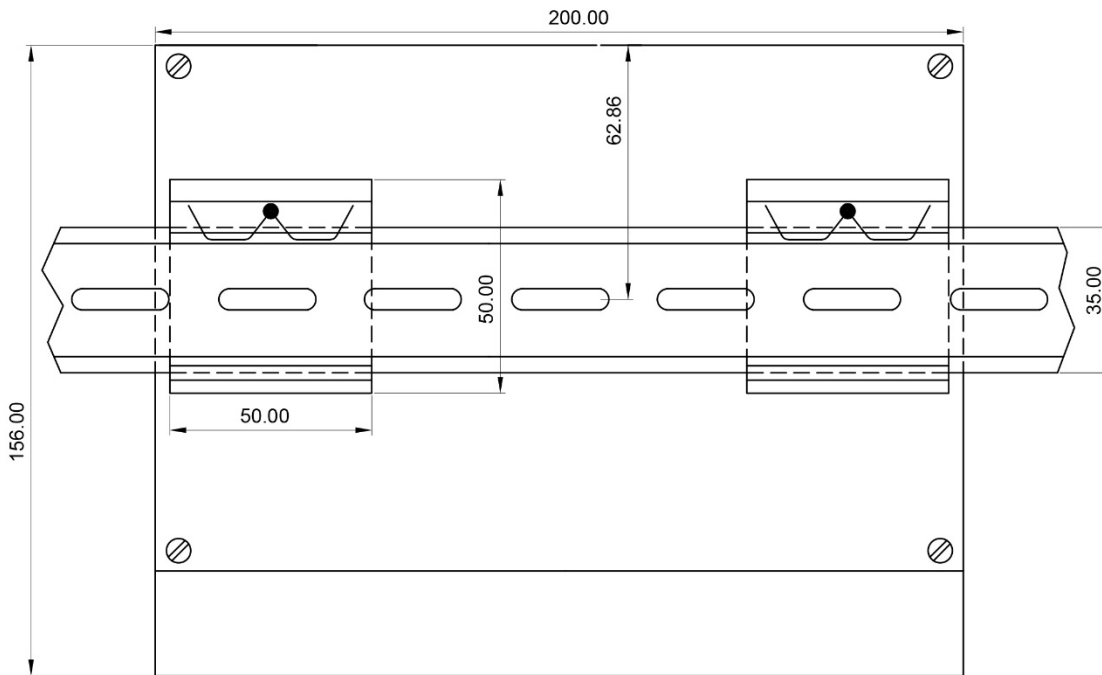

Back Plate Option / DIN-Rail Standard

(The CPS-EC1500 is always delivered for DIN-rail mount, the back-plate is an optional part that shall be mounted from the customer. The threads from the DIN-rail mounting brackets shall be used. All screws are included into the Back-Plate Kit.)

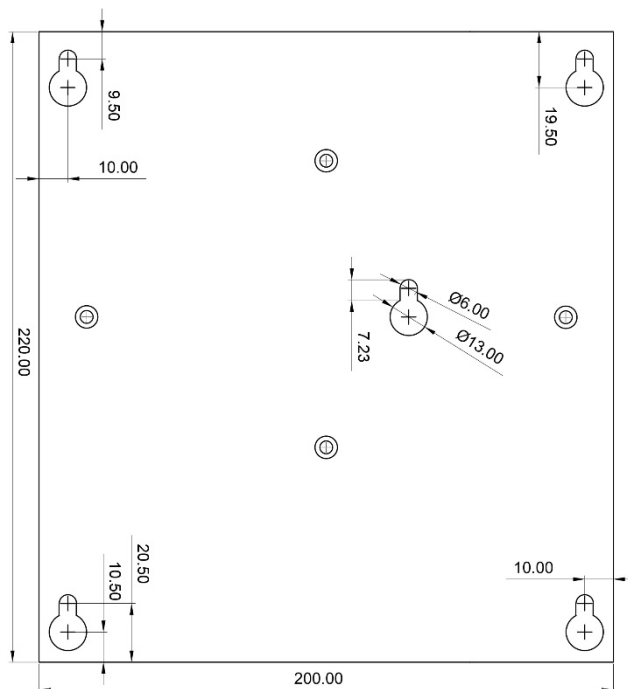

Connections

Clamping Yoke Connector Specifications

	Input / Output connections	Signal connections plugs
Tightening torque min. – max.	1,2 – 2,2Nm (blade 1,0x5,5 DIN5264)	0,2 – 0,25Nm (blade 0,4x2,2 DIN5264)
Touch-safe protection acc. to DIN VDE 0470	IP20 plugged/ IP10 unplugged	Not applicable
Clamping range, min. – max.	0,5 – 16mm ² / AWG26 – AWG6	0,2 – 1,5mm ² / AWG28 – AWG14
Solid, H05(07) V-U min. – max.	0,5 – 16mm ²	0,2 – 1,5mm ²
Stranded, H05(07) V-U min. – max.	6 – 16mm ²	0,2 – 1,5mm ²
Flexible, H05(07) V-U min. – max.	0,5 – 16mm ²	0,2 – 1,5mm ²
w. plastic collar ferrule, DIN 46228 pt 4 min. – max.	2,5 – 10mm ²	0,2 – 1,5mm ²
w. wire end ferrule, DIN 46228 pt 1, min. – max.	2,5 – 10mm ²	0,2 – 1,5mm ²
Plug gauge in accordance with EN 60999 a x b; ø	5,4 x 5,1mm; 5,3mm	2,4 x 1,5mm; 2,3mm
Pitch (P)	10,16mm	3,5mm

Wire Stripping Length (fine wired)

Nominal Cross Section	Wire End Ferrule	Stripping Length	Wire End Ferrule	Stripping Length
0,25mm ²	H0,25/5	5mm	H0,25/10 HBL	8mm
0,5mm ²	H0,5/6	6mm	H0,5/12 OR	8mm
1,0mm ²	H1,0/6	6mm	H1,0/12 GE	8mm
2,5mm ²	H2,5/12	12mm	H2,5/19D BL	14mm
4,0mm ²	H4,0/12	12mm	H4,0/20 GDR	14mm
6,0mm ²	H6,0/20	12mm	H6,0/20 SW	14mm
10,0mm ²	H10,0/12	12mm	H10,0/22 EB	15mm

The length of ferrules is to be chosen depending on the rated voltage. The outside diameter of the plastic collar should not be larger than the pitch (P)

Ordering Information

Ordering Codes

Product Code	Information	Article Number
CPS-EC1000.024(R2)	24V	3041105001CA
CPS-EC1000.036(R2)	36V	3041105002CA
CPS-EC1000.048(R2)	48V	3041105003CA
CPS-EC1000.060(R2)	60V	3041105004CA
CPS-EC1000.072(R2)	72V	3041105005CA
CPS-EC1000.110(R2)	110V	3041105006CA
CPS-EC1000.150(R2)	150V	3041105007CA
CPS-EC1000.220(R2)	220V	3041105008CA
CPS-EC1000.300(R2)	300V	3041105009CA
Back Plate Kit	Base Plate / Hart mount plate kit including screws	3041105001CA



Safety regulations: Please read these instructions completely before using the equipment. Keep these instructions on to hand. The device may only be operated by trained specialist staff.

Installation:

- 1) The device is designed for devices and systems that meet the standard requirements for hazardous voltages, power, and fire prevention.
- 2.) Installation and service only by trained persons. The AC power must be switched off. The work is to be labelled; accidental reconnection of the system must be prevented.
- 3.) Opening the device, its modification, loosening bolts, or operation outside the specified herein specification or in an unsuitable environment, has the immediate loss of warranty to follow. We disclaim any responsibility for any resulting damage to persons or things.
- 4.) Note: The device must not be operated without an upstream circuit breaker (CB). We recommend the use of B-Type 16A for 230Vac and 32A for 115Vac. It is prohibited to use the unit without PE. It may be necessary upstream device has a power switch.

Warning:

Non-compliance these warnings can result in fire and serious injury or death.

1. Never operate device without PE connection.
2. Before connecting the device to the AC network, make wires free of voltage and assure accidentally switch on.
3. Allow neat and professional cabling.
4. Never open nor try to repair the unit. Inside are dangerous voltages that can cause electrical shock hazard.
5. Avoid metal pieces or other conductive material to fall into the item
6. Do not operate the device in damp or wet conditions
7. Do not operate the unit under EX-conditions



All parameters base on 15 minutes run-in @ full load / 25°C / 230Vac 50/60Hz, as otherwise stated.